

Fig. 6-1 Pontiac Strato-Streak V-8 Engine

ENGINE MECHANICAL

CONTENTS OF THIS SECTION

SUBJECT	PAGE	SUBJECT	PAGE
General Description	6-1	Minor Repairs (Cont'd)	
General Information on Servicing the V-8 Engine	6-7	Timing Chain—Remove and Replace	6-19
Periodic Service	6-8	Camshaft—Remove and Replace	6-19
Adjustments on Car	6-8	Oil Pan or Gaskets—Remove and Replace ..	6-20
Minor Repairs		Oil Pump—Remove and Replace	6-21
Intake Manifold or Gasket— Remove and Replace	6-9	Rear Main Bearing Oil Seal— Remove and Replace	6-21
Right Side Exhaust Manifold or Gasket— Remove and Replace	6-10	Connecting Rod Bearings— Remove and Replace	6-22
Left Side Exhaust Manifold or Gasket— Remove and Replace	6-10	Main Bearings—Remove and Replace	6-22
Intake and Exhaust Valve Stem Seal or Shield—Remove and Replace	6-11	Connecting Rod and Piston Assembly— Remove and Replace	6-23
Push Rod Cover or Gasket— Remove and Replace	6-11	Flywheel or Clutch Pilot Bearing— Remove and Replace	6-23
Cylinder Head or Gasket— Remove and Replace	6-12	Engine Removal	6-24
Rocker Arm Stud—Remove and Replace	6-13	Engine Overhaul	
Hydraulic Valve Lifter—Remove and Replace	6-14	Engine Disassembly	6-24
Engine Insulators—Remove and Replace	6-15	Cylinder Head and Valves—Overhaul	6-26
Harmonic Balancer—Remove and Replace ..	6-16	Hydraulic Valve Lifter Service	6-30
Timing Chain Cover, Gasket, Oil Seal, or Fuel Pump Eccentric— Remove and Replace	6-16	Cylinder Block, Crankshaft, Camshaft and Related Parts—Clean and Inspect	6-33
Cylinder Block and Head Core Hole and Oil Passage Plug Replacement	6-18	Connecting Rod and Piston Service	6-36
		Camshaft Bearing Replacement	6-42
		Assembly of Engine	6-43
		Engine Installation	6-47
		Specifications	6-48
		Special Tools	6-52

GENERAL DESCRIPTION

Pontiac's Strato-Streak 90° V-8 engine is used in all models (Fig. 6-1). Displacement is 347 cu. in. provided by a $3\frac{15}{16}$ in. bore and $3\frac{9}{16}$ in. stroke. Two compression ratios are available. The 10.0:1 compression ratio engine requires the use of premium fuel and is standard on Hydra-Matic models. The 8.5:1 compression ratio engine utilizes regular fuel and is used in Synchro-Mesh models. The difference in compression ratios is obtained by the use of different pistons (see page 6-4). Since there is no external difference in the two engines, an "L" with a circle around it is stamped on the serial number pad of the 8.5:1 compression engine (see "Serial Number", page 6-7). Engines used in Chieftain models are equipped with 2

barrel carburetors. All Super Chief and Star Chief models use engines with 4 barrel carburetors. Engine torque and horsepower are shown in "SPECIFICATIONS", page 6-48.

The engine (Fig. 6-2) features completely machined combustion chambers, overhead valves, ball pivot rocker arm construction, harmonic balancer, hydraulic lifters, aluminum pistons, gusher type valve cooling, straight valve guides, superior crankcase ventilation and lubrication systems, preheating of the carburetor throat to prevent carburetor icing, and large displacement combined with high compression ratio for utmost performance and economy.

Detailed descriptions of gusher type valve cooling, crankcase ventilation, and the lubrication system are

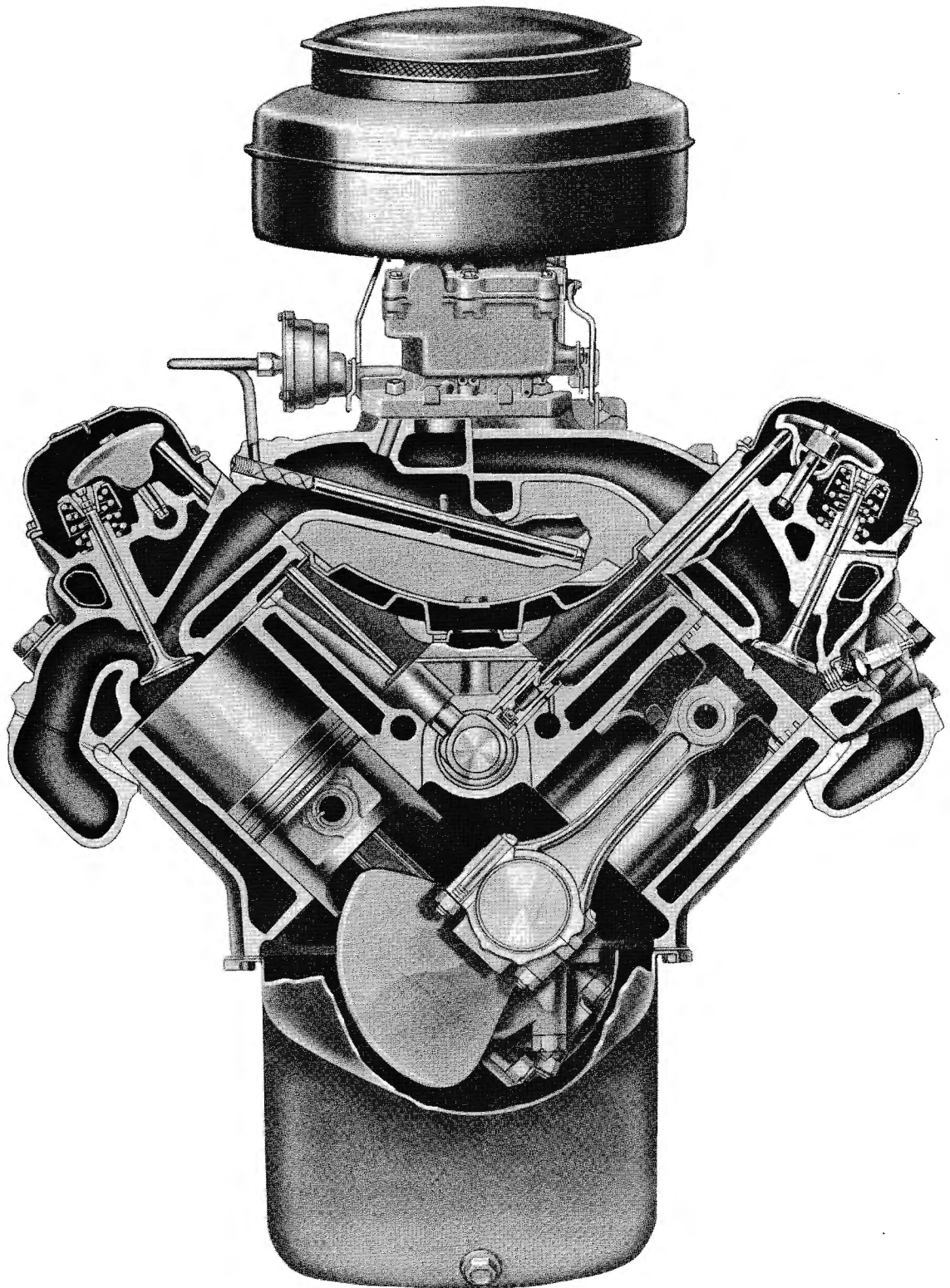

Fig. 6-2 Transverse Cross Section of Engine

given in "ENGINE COOLING AND LUBRICATION", page 6A-1. Mechanical details, such as valves, rocker arms, hydraulic valve lifters, etc. are described on the following pages.

Detailed mechanical specifications begin on page 6-48.

Detailed descriptions of gusher type valve cooling, crankcase ventilation and lubrication systems are given in Engine Cooling and Lubrication, page 6A-1. Mechanical details such as valves, rocker arms, hydraulic valve lifters, etc. are described on following pages. Detailed mechanical specifications begin on page 6-48.

CYLINDER BLOCK

The cylinder block has two banks of four cylinders each, cast at 90° to each other. Left bank cylinders are numbered 1-3-5-7 and right bank cylinders are numbered 2-4-6-8.

The left bank is set slightly behind the right bank. This provides room for mounting the fuel pump in front of the engine on the left side where it receives direct cooling from the fan. Also it permits a shorter fuel line. Both these factors minimize the possibility of vapor lock. This arrangement of cylinders also provides for mounting the generator on the right side. This location is advantageous since it places the most severe turn in the belt on the slack, or lowest tension side, of the belt.

All main bearing caps are doweled to the cylinder block to insure accurate alignment and facilitate assembly.

Cylinders are completely encircled by water jackets. For details of the engine cooling system see page 6A-1.

The rear main bearing cap is sealed by a cork and neoprene composition gasket between the cap and the oil pan (Fig. 6-3).

CYLINDER HEADS

Left and right cylinder heads are identical except for the plug inserted in the end of the water passage in which the water distributing tube is located. With this design the same casting is used for both heads.

Valve seats are completely surrounded by water and a water distributing tube is used to forcibly direct the cool incoming water against valve seats. Each head has an oil gallery which feeds oil to the

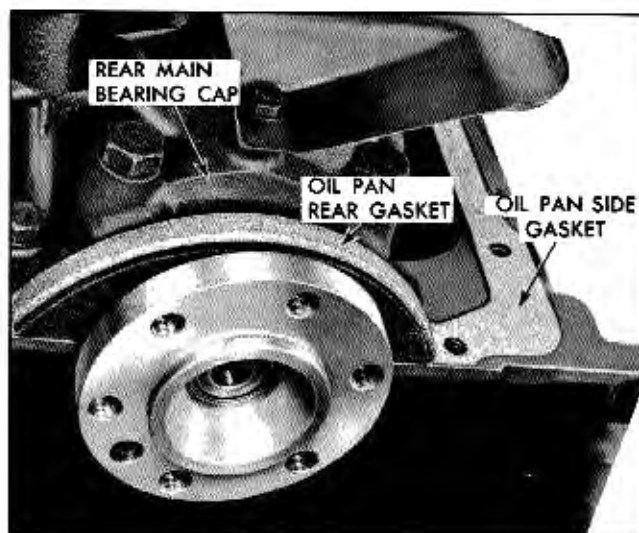

Fig. 6-3 Oil Pan Gaskets

rocker arm studs to provide lubrication of the upper valve train parts.

Cylinder head casting date is located at the right front corner of the right head and the left rear corner of the left head.

CRANKSHAFT AND BEARINGS

The crankshaft is cast pearlitic malleable iron and is supported by five main bearings. The rear main bearing shells have two oil grooves (Fig. 6-4). The front oil groove has an oil hole in the center while the rear oil groove has three oil drain holes evenly spaced. The upper and lower shells are not interchangeable due to location of tang slots in block and cap. Torsional vibration is dampened by the harmonic balancer mounted on the front end of the crankshaft.

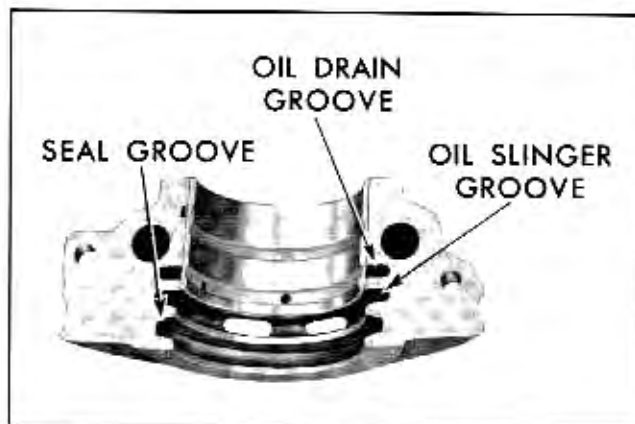

Fig. 6-4 Rear Main Bearing Cap and Shell

The rear main bearing is sealed by a packing seated in a chamfered groove in the block and bearing cap (Fig. 6-4). A slinger on the crankshaft in front of the seal and the drain groove in the rear main bearing prevent an excess of oil from getting to the seal.

CAMSHAFT AND DRIVE

Two different camshafts are used. One is designed to be used in engines with Hydra-Matic transmission, and one is designed to be used in engines with the Synchro-Mesh transmission. Camshafts are identified by stamped "O" on Synchro-Mesh Model and stamped "2" on Hydra-Matic Model. The stamp mark is located on front end of camshaft.

The camshafts are cast from alloy iron. Cam lobes are ground, hardened and tapered with the high side toward the rear. This, coupled with a spherical face on the lifter causes valve lifters to rotate. The camshaft is supported by five bearings.

A one inch wide, 60 link timing chain is used to drive the camshaft. The 42 tooth camshaft drive sprocket is made from cyanide hardened, cast alloy iron, while the 21 tooth crankshaft sprocket is made from case hardened steel.

PISTONS AND CONNECTING RODS

The pistons are aluminum alloy, tin plated, with a steel band to control expansion and give added strength. Pistons are cam ground so that the diameter across the thrust faces is larger than the diameter fore and aft of the engine. This forces expansion and contraction to occur to the front and rear and thus provides a constant diameter across the thrust faces. A circular steel band cast into the piston above the pin boss provides further assurance that the thrust diameter will not change. Two compression rings and one oil control ring are used, all of which are located above the piston pin.

The pistons used in the 10.0:1 compression ratio engine are flat on top as shown in Fig. 6-5. Pistons used in the 8.5:1 compression ratio engine are dished as shown in the illustration and also have an "L" cast on the back side. Dishing provides the larger combustion chamber volume required for the lower compression ratio.

Piston pins are offset $\frac{1}{16}$ " toward thrust side (right hand side) to provide a gradual change in thrust pressure against the cylinder wall as the piston travels its path (Fig. 6-6). This feature provides quieter engine operation. Pins are hardened steel and

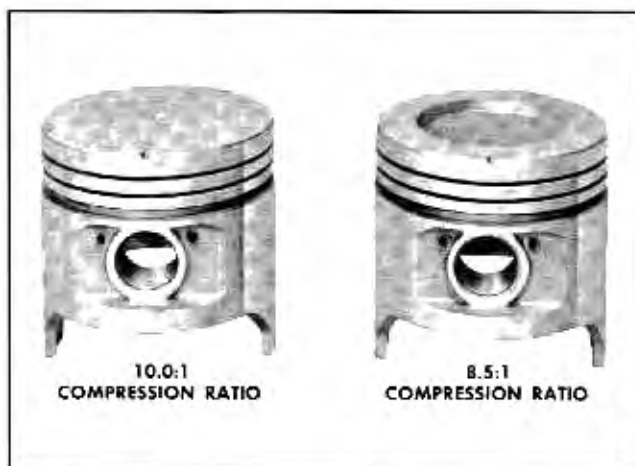

Fig. 6-5 Standard and High Compression Pistons

have a floating fit in the pistons. They are retained in the piston by snap rings.

I-beam forged connecting rods are used. A lubrication groove between the connecting rod and cap directs a jet of oil onto the opposite cylinder wall to lubricate the piston and rings and to provide splash for lubricating the piston pins.

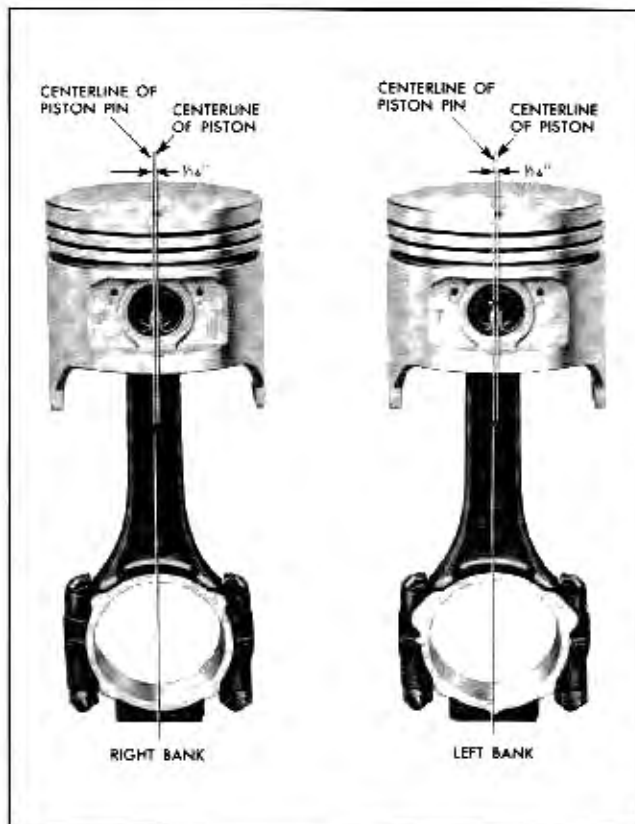

Fig. 6-6 Connecting Rod and Piston Assembly

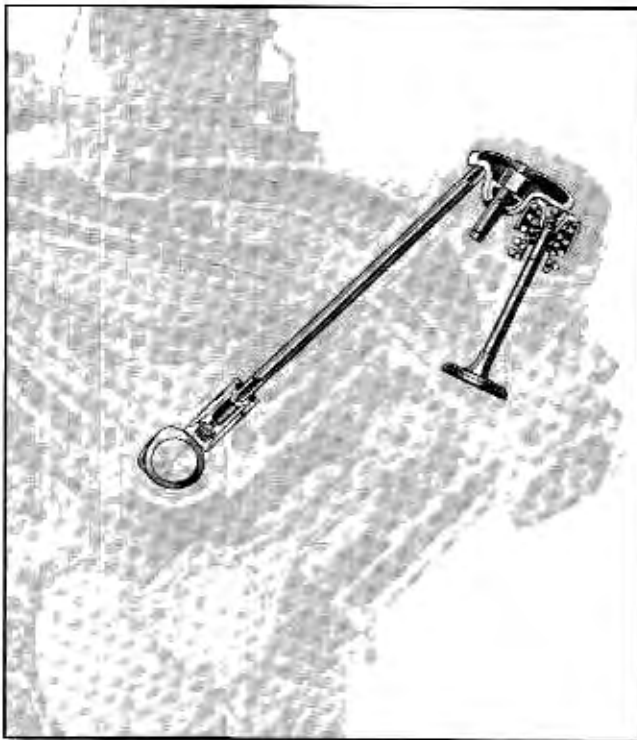

Fig. 6-7 Fixed Setting Rocker Arm Valve Train



Fig. 6-8 Cross Section View of Intake Valve Guide Vented to Atmosphere

VALVE TRAIN

A very simple ball pivot type valve train is used (Fig. 6-7). Motion is transmitted from the camshaft through the hydraulic lifter and push rod to the rocker arm. The rocker arm pivots on its ball and transmits the camshaft motion to the valve. The rocker arm ball is retained by a self-locking nut.

The maximum in durability is assured by the use of cyanide-hardened stamped steel rocker arms. In addition all friction points of the valve train are positively lubricated (see page 6A-5).

The cylinder head has passages for venting intake valve guides to atmosphere (Fig. 6-8) along with straight valve guides cast integral. External shields are used on both intake and exhaust valves to reduce the amount of oil splashed against stems. Valve stem seals are used on exhaust as well as intake valves to prevent oil from entering the valve guides.

HYDRAULIC VALVE LIFTERS

Hydraulic lifters are used to keep all parts of the valve train in constant contact. In other words each lifter is an automatic adjuster maintaining zero

lash under all conditions. This insures precision valve timing and silent operation, increases valve life, and eliminates the need for tappet adjustment.

The hydraulic lifter assembly (Fig. 6-9) includes: the cast iron body which rides in the cylinder block boss, the plunger, push rod seat, plunger spring, ball check valve, ball check valve retainer, and retainer ring.

The hydraulic valve lifter functions as follows: When the lifter is riding on the low point of the cam, the plunger spring keeps the plunger and push rod seat in contact with the push rod.

When the lifter body begins to ride up the cam lobe, the ball check valve cuts off the transfer of oil from the reservoir below the plunger. The plunger and lifter body then rise as a unit pushing up the push rod and opening the valve.

As the lifter body rides down the other side of the cam the plunger follows with it until the valve closes. The lifter body continues to follow the cam to its low point, but the plunger spring keeps the plunger in contact with the push rod. The ball check valve will then move off its seat and the lifter reservoir will remain full.

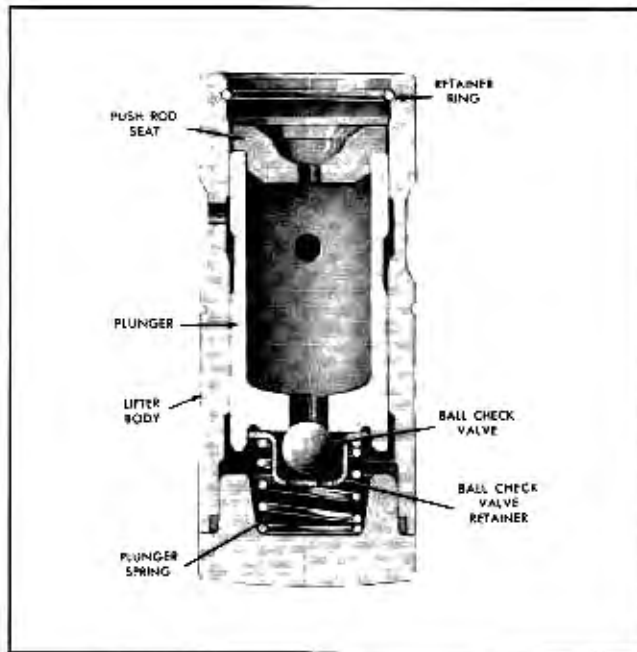

Fig. 6-9 Sectional View of Valve Lifter Assembly

During operation a small amount of oil leaks out of the lifter between the plunger and body. A controlled amount of leakage is important to provide continuous adjustment of the plunger position within the lifter. This leakage is called "leak down" and must be within certain limits to provide correct operation (see page 6-32).

Oil is supplied to the lifter by the cylinder block oil gallery to replace that lost through leak down. The annular groove around the outside of the lifter body indexes with the passage drilled from the gallery to the lifter boss. Oil then enters the lifter from this groove and passes into the plunger cavity. From the plunger cavity, oil under pressure is also fed up the push rod to lubricate the friction area between the upper end of the push rod and the rocker arm.

FUEL DISTRIBUTION SYSTEM

The intake manifold is designed to provide fuel passages which are short and practically equal in length. With the two barrel carburetor each throat of the carburetor feeds four cylinders as shown in Fig. 6-10. The intake manifold used with the four barrel carburetor is fundamentally the same as with two barrel but has four openings to index with the carburetor throats. With the four barrel carburetor the two throats on the left side feed four cylinders and the two throats on the right side feed four cylinders (Fig. 6-11).

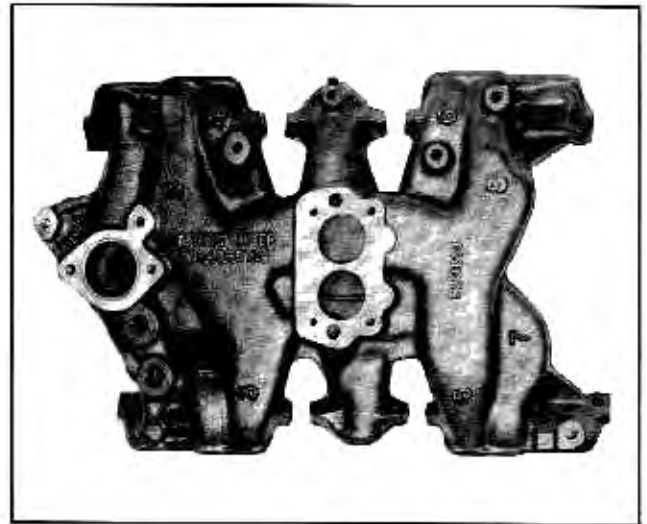

Fig. 6-10 Intake Manifold—2 Barrel Carburetor

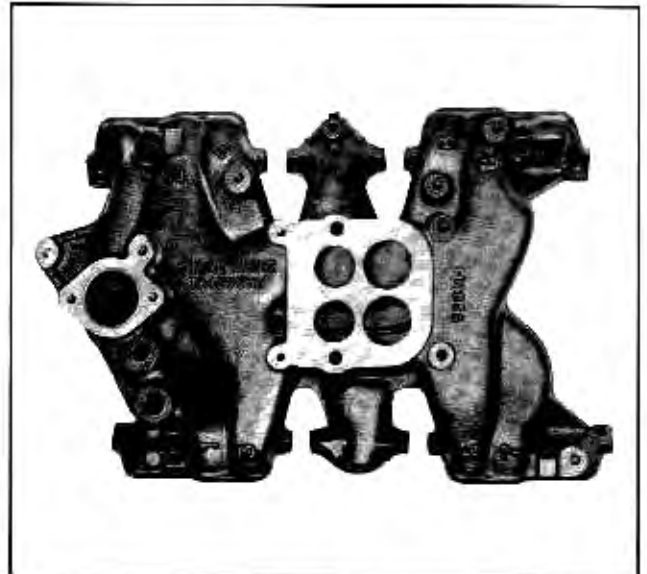

Fig. 6-11 Intake Manifold—4 Barrel Carburetor

A stove is included in the intake manifold surrounding the risers which lead to the carburetor. When the engine is cold, exhaust gases from the right bank of cylinders pass through a passage in the intake manifold to circulate around and heat the stove. The fuel-air mixture passing from the carburetor to the cylinders is thereby pre-heated to the desired temperature for proper combustion.

Exhaust gases also pass from the stove up into a passage in the throttle body of the carburetor. This serves to heat the carburetor throttle body when the engine is cold, thereby preventing carburetor icing and subsequent stalling of the engine during warm-up.

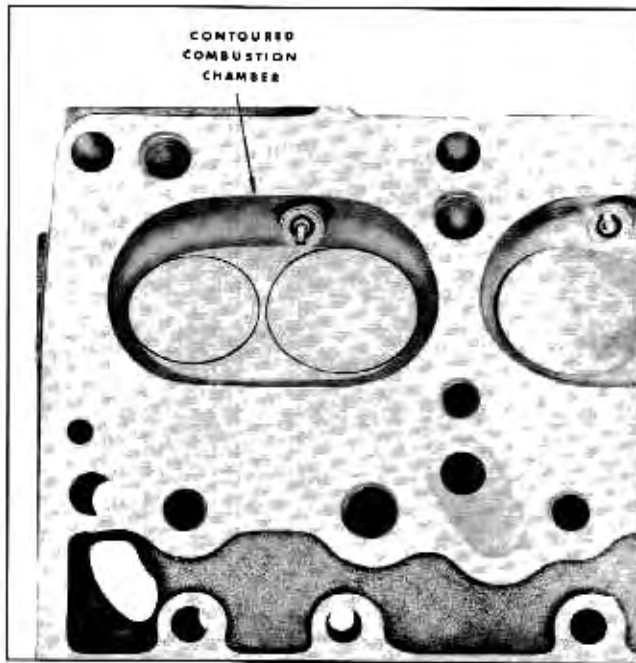

Fig. 6-12 Cylinder Head Viewed From Bottom

EXHAUST SYSTEM

Two cast iron manifolds are used, one for each bank of cylinders. Exhaust gases from the left manifold pass through a crossover pipe which passes beneath the engine to the right side. At this point the exhaust pipe from the right manifold joins the crossover pipe and gases are carried rearward to the muffler and tailpipe. A thermostatically controlled valve in the outlet of the right manifold blocks the passage of exhaust out of this manifold when the engine is cold. Exhaust from the cylinders on the right bank will then pass through the intake manifold exhaust crossover passage and out the left cylinder head and exhaust manifold.

In passing through the crossover passage, the hot gases serve to heat the intake manifold stove and the carburetor throttle body as outlined on page 6-6.

COMBUSTION CHAMBERS

Combustion chambers are completely machined to insure accurate volume control and uniform shape for all cylinders. Spark plugs are located near intake valves for maximum power and to properly fire economically lean mixtures.

The contoured wedge shape of the combustion chamber (Fig. 6-12) minimizes the possibility of detonation, facilitates breathing and provides swirling turbulence for smooth, complete combustion.

Intake valves are large and have 30° seat angles to further provide easy breathing for high combustion efficiency. Exhaust valve seat angle is 45°.

SERIAL NUMBERS

The engine-car serial number is located on a machined pad on the front of the right-hand bank of the block (Fig. 6-53). Another number will be found on the front of the block near the right edge of the timing chain cover. This is the production engine number used for material control purposes during manufacture. The production engine number should be included on AFAs or P.I. Reports concerning the engine.

An identification mark for the compression ratio of the engine is also located on the car serial number pad. Engines with 8.5:1 compression ratio will have an "L" with a circle around it stamped on the serial number pad. The letter "L" will be approximately 1/4" high. Engines with 10.0:1 compression ratio will have no additional mark on the serial number pad.

GENERAL INFORMATION ON SERVICING THE V-8 ENGINE

Cleanliness is a primary factor when servicing the V-8 engine. The slightest particle of dirt that finds its way into a hydraulic lifter may cause a malfunction.

Since any dirt which may enter the oil galleries or passages in the engine could eventually get to a lifter, cleanliness should be exercised when any part of the engine is removed or disassembled. When a cylinder head is removed for any purpose, it is necessary to

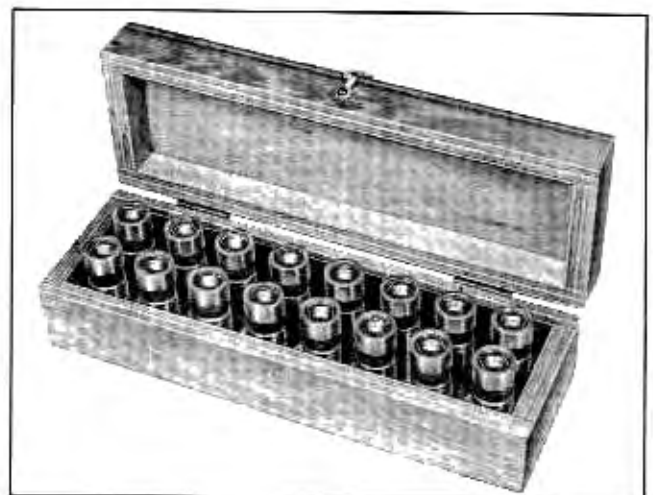

Fig. 6-13 Valve Lifter Storage Box J-5763

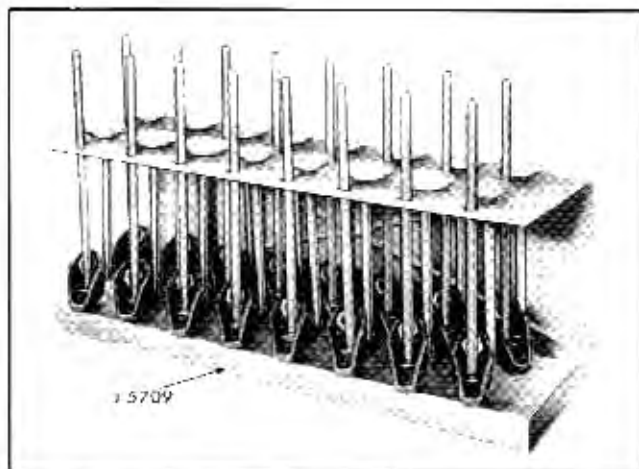

Fig. 6-14 Valve and Valve Train Holding Stand J-5709

remove the push rod cover. This exposes the lifters to any dirt which may fall from the upper portion of the block or which may be carried in the air. Thus, it is wise to cover the lifter galleries until ready to reassemble the engine.

When lifters are removed for any reason, they should immediately be placed in order in Valve Lifter Storage Box J-5763 (Fig. 6-13). This is important for two reasons. First, it is the easiest way to keep lifters clean. Second, lifters should always be replaced in the same bosses from which they were removed.

Valves, valve lifters, push rods, rocker arms, rocker arm balls, and rocker arm ball nuts should always be kept in sets and returned to their original positions. These parts will tend to mate as the engine operates and will provide more satisfactory operation when kept together. By storing lifters in Storage Box J-5763 and valves, push rods, rocker arms, balls and nuts in Holding Stand J-5709 (Fig. 6-14), whenever they are removed, they can easily be kept in sets for identification during assembly. In addition to keeping the parts in sets, the push rods should be replaced with the same end up. In other words, the same end will contact the rocker arm as before the engine was disassembled. The upper end can usually be identified by the polished surface which contacts the rocker arm. Push rods will also be polished somewhat in the area where the rod passes through the head.

When hydraulic valve lifters are disassembled, the various parts of each lifter must be kept together. This is especially important since the lifter body and plunger are selectively fitted. The use of the special tray included with Cleaning Tank J-5821 will aid in keeping the parts of each lifter together when lifters are being serviced.

Cylinder head screws should be installed without thread sealer of any kind.

When raising or supporting the engine for any reason, do not use a jack under the oil pan. Due to the small clearance between the oil pan and the oil pump, jacking against the oil pan may cause it to be bent against the pump. The result would be a telegraphed noise which would be difficult to trace.

It should be kept in mind, while working on the engine, that the twelve volt electrical system is capable of violent and damaging short circuits. When performing any work where electrical terminals could possibly be grounded, the ground cable of the battery should be disconnected.

Any time the carburetor or air cleaner is removed, the intake opening should be covered. This will protect against accidental entrance of foreign material which could follow the intake passage into the cylinder and cause extensive damage when the engine is started.

PERIODIC SERVICE

There are no periodic services required on the mechanical portions of the engine. Periodic services connected with the engine consist of tune-up, lubrication, replacing cartridge in oil filter, etc. Procedures and recommendations for these services will be found in appropriate sections of this book.

ADJUSTMENTS ON CAR

FAN BELT—ADJUST

The engine fan belt tension should be such as to give $\frac{1}{4}$ " movement of the belt from normal with approximately 8 lbs. force (14 lbs. with air conditioning) applied midway between generator pulley and fan pulley. If belt tension is incorrect, loosen generator strap bolt and swing generator in or out to give correct belt tension. Tighten all generator mounting bolts after adjusting belt.

POWER STEERING PUMP BELT—ADJUST

See Steering Section, page 9-1.

IGNITION TIMING—ADJUST

See Electrical Section, page 12-1.

CARBURETOR—ADJUST

See Engine Fuel Section, page 6B-1.

MINOR REPAIRS

INTAKE MANIFOLD OR GASKET—REMOVE AND REPLACE

REMOVE

1. Drain water from radiator and from each side of cylinder block. **NOTE:** Most of the water may be drained from the block through the radiator drain by raising rear end of car approximately 15-18 inches off the floor.

2. Remove air cleaner.

3. Remove upper radiator hose. **NOTE:** If condition of hose does not warrant replacing with new hose, possible damage to hose and clamps can be reduced by leaving hose attached to water outlet. In this case water outlet may be disconnected from manifold and moved out of way.

4. Disconnect heater hose from fitting, remove nut retaining hose bracket to manifold, and move hose with bracket out of way.

5. Disconnect wires from generator and thermogauge unit and remove wire harness from clip on generator end plate; remove screws retaining generator mounting bracket to manifold; remove bolt retaining generator adjusting strap to cylinder head water inlet and remove generator.

6. On power steering equipped cars, remove screws retaining power steering pump mounting bracket to timing chain cover; lay pump, with hoses attached, on left fender skirt. **CAUTION:** Before laying pump on fender skirt disconnect battery ground strap to prevent pump from grounding "BAT" terminal of regulator.

7. Remove fuel pipe connecting fuel pump to fuel filter.

8. Remove cap screw retaining vacuum pipe clip to left cylinder head.

9. Disconnect primary and secondary wires from coil.

10. Disconnect right cylinder head spark plug wires and wire support and distributor primary wire; remove distributor cap and lay cap and wires on left side of engine.

11. Disconnect vacuum pipe between carburetor and vacuum pump at vacuum pump. On cars equipped with power brakes, remove power brake hose from vacuum check valve and vacuum pipe.

12. Remove distributor to carburetor vacuum pipe.

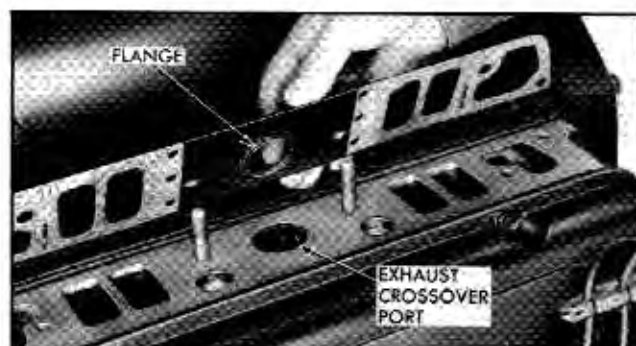

Fig. 6-15 Installing Intake Manifold Gasket

13. Disconnect throttle rod from carburetor.

14. Remove screws retaining throttle control engine bracket assembly (Hydra-Matic models) to manifold, and tie bracket and throttle rod against firewall.

15. Remove intake manifold retaining screws and nuts, and remove manifold and gaskets.

REPLACE

NOTE: When a new manifold is to be installed, transfer carburetor, ignition coil, water outlet, thermostat, heater hose fitting, thermogauge fitting, and manifold choke heat tube to new manifold. Use new gaskets on those units requiring gaskets.

1. Install new gasket on each cylinder head so that flange of metal center section of gasket fits into exhaust crossover port of head (Fig. 6-15).

2. Position manifold on engine and install cap screws and nuts loosely, except nut which retains heater hose bracket and the two screws which retain the throttle control engine bracket on Hydra-Matic models.

3. Position throttle control engine bracket assembly (Hydra-Matic models) on manifold and install cap screws.

4. Position heater hose bracket and install retaining nut.

5. Tighten all nuts and screws evenly to 40-45 lb. ft. torque.

6. Connect throttle rod to carburetor.

7. Install vacuum pipe connecting fuel and vacuum pump to carburetor. On cars equipped with power brakes, install vacuum pipe connecting flexible hose to carburetor.

8. Fasten vacuum pipe retaining clip to left cylinder head.
9. Install fuel pipe connecting fuel pump to fuel filter.
10. Connect heater hose to fitting.
11. Install upper radiator hose.
12. On cars equipped with power steering, install pump on timing chain cover.
13. Install distributor cap and connect primary and secondary wires to ignition coil.
14. Install generator, connect wires, and fasten wire harness in clip on generator end plate.
15. Connect thermogauge engine unit terminal.
16. Adjust fan belt tension (page 6-8).
17. Install vacuum pipe connecting distributor vacuum advance unit to carburetor.
18. Install spark plug wire support and spark plug wires.
19. Connect battery ground strap.
20. Momentarily touch jumper lead to "BAT" and "GEN" terminals on generator regulator to re-polarize generator.
21. Replace air cleaner.
22. Close drain cocks and fill radiator to proper level.
23. Check Hydra-Matic linkage adjustment (see Pontiac Hydra-Matic Shop Manual).

RIGHT SIDE EXHAUST MANIFOLD OR GASKET— REMOVE AND REPLACE

REMOVE

1. Remove screws from exhaust crossover pipe flange on right side of engine.
2. Remove oil level indicator (dipstick) and upper part of oil level indicator tube.
3. Straighten tabs on manifold front and rear individual screw locks and remove manifold attaching screws, manifold, and gasket. **NOTE:** Locks are used on the front and rear pairs of screws only.
4. Remove old gasket from exhaust crossover pipe.

REPLACE

1. Thoroughly clean gasket surfaces of cylinder head and exhaust manifold. Check condition of heat control valve and related parts.
2. Place new gasket on exhaust crossover pipe.
3. Replace exhaust manifold and new gasket. Use new individual manifold screw locks on front and rear pairs of screws. **NOTE:** Place manifold outlet in position over end of crossover pipe but do not permit weight of manifold to rest on crossover pipe. Since the end holes of the gasket are slotted, installation of gasket may be simplified by first installing the manifold using only the front and rear screws to retain manifold. Allow clearance of about $\frac{3}{16}$ " between cylinder head and exhaust manifold. After inserting the gasket between head and manifold the remaining screws may be installed.
4. Tighten all screws evenly and securely (25 lb. ft. torque). Bend tabs of screw locks against screw heads. **NOTE:** Be sure tabs are bent against sides of screw heads, not on top of screw heads.
5. Replace oil level indicator.
6. Position exhaust crossover pipe against manifold connector with new gaskets. Use two thin (.075") gaskets or one thick (.135") gasket. Install bolts and tighten securely.
7. Replace engine side apron.

LEFT SIDE EXHAUST MANIFOLD OR GASKET— REMOVE AND REPLACE

REMOVE

1. Remove engine left side apron from frame on both sides.
2. Remove exhaust crossover pipe flange screws on both sides of engine and lower crossover pipe as far as possible.
3. Remove gaskets from crossover pipe.
4. Straighten tabs on manifold individual screw locks. (Tabs can be straightened from beneath car by using long handled screwdriver.) **NOTE:** Locks are used on the front and rear pairs of screws only.
5. Remove the two front and two rear manifold attaching screws. (Screws can be removed from beneath car using universal socket and extension.)
6. Remove battery, battery support, and support brackets.

7. Disconnect battery ground cable from left cylinder head stud; remove cable and clip.

8. On cars equipped with power brakes remove vacuum pipes with vacuum check valve attached. (Disconnect at reservoir, at pipe leading to carburetor, and at hose leading to brake unit.)

9. Remove two center attaching screws. **NOTE:** On power steering equipped cars, the rear center screw cannot be completely removed, however, it will come out as the manifold is moved forward.

10. Move manifold forward and remove from engine.

REPLACE

1. Thoroughly clean gasket surfaces of cylinder head and exhaust manifold.

2. Place manifold and gasket in position against cylinder head and install two center screws. (On power steering equipped cars, place rear center screw in manifold before positioning manifold against cylinder head.)

3. Install remaining screws and new screw locks. **NOTE:** Rearmost screw can be started from beneath car using socket and extension.

4. Tighten all screws evenly and securely (25 lb. ft. torque). Bend tabs of screw locks against screw heads.

5. Install exhaust crossover pipe using new gaskets. Use two thin (.075") gaskets or one thick (.135") gasket at each manifold. **NOTE:** On power steering equipped cars, place left side of crossover pipe in position first, position right side and loosely install screws in right side. Start screws in left side. Tighten all screws securely.

6. Install engine side aprons.

7. Replace power brake vacuum pipes, ensuring all vacuum connections are tight.

8. Replace battery ground cable clip and connect cable to cylinder head stud.

9. Replace battery supports, battery box, and battery. **NOTE:** Clean top of battery and terminals.

INTAKE OR EXHAUST VALVE STEM SEAL OR SHIELD—REPLACE

1. Remove rocker arm cover, spark plug and distributor cap.

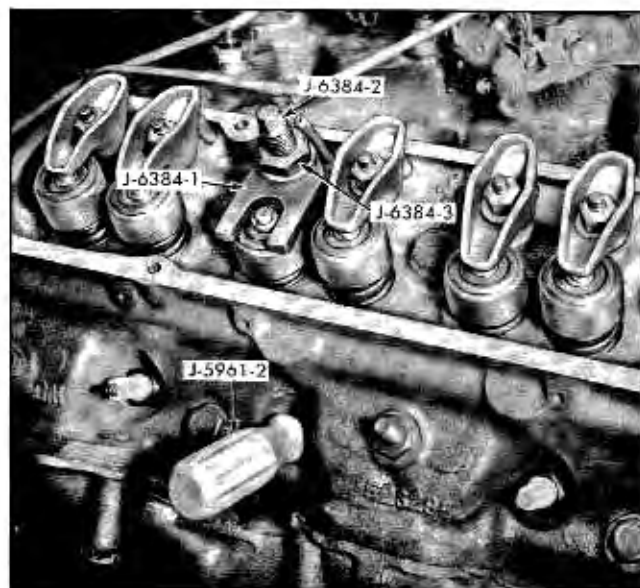

Fig. 6-16 Valve Spring Compressed

2. Remove rocker arm.

3. After removing rocker arm, thread valve spring compressor stud J-6382-2 on rocker arm stud and compress valve spring using compressor J-6384-1 and nut J-6384-3 while holding valve up with Valve Holder J-5961-2 (Fig. 6-16). Remove valve spring retainer cup locks and then remove valve spring compressor, valve spring retainer cup shield and valve stem seal.

4. Install new part or parts, compress springs with Valve Spring Compressor J-6384-1 and Nut J-6384-3 (while holding valve up with Holder J-5961-2), install valve stem seal, and install retainer cup locks. Remove spring compressor and valve holder, then test valve stem seal using suction cup end of tool J-5751.

5. Install rocker arm, tighten rocker arm ball retaining nut to 15 lb. ft. torque.

6. Replace rocker arm cover, spark plug, distributor cap and connect spark plug wire.

PUSH ROD COVER OR GASKET—REMOVE AND REPLACE

REMOVE

1. Remove intake manifold as described on page 6-9.

2. Remove crankcase ventilator outlet pipe brackets from rear of right cylinder head and flywheel housing, and remove ventilator outlet pipe.

3. Remove screws from push rod cover and remove cover.

REPLACE

1. Inspect condition of gasket on crankcase ventilator baffle; replace if necessary using gasket cement.

2. Cement new gasket on push rod cover.

3. Replace push rod cover and tighten screws to 10 lb. ft. torque.

4. Replace crankcase ventilator outlet pipe and brackets, slipping pipe into neoprene seal on push rod cover. Neoprene seal should seat on push rod cover. (A light coat of oil will facilitate installation of pipe into seal.)

5. Install intake manifold as described on page 6-9.

CYLINDER HEAD OR GASKET—REMOVE AND REPLACE

REMOVE

1. Remove intake manifold, push rod cover, and rocker arm cover.

2. Remove battery ground strap and engine ground strap from left head or engine ground strap from right head. (Also remove the Hydra-Matic oil level indicator tube bracket and engine oil level indicator.)

3. Loosen all rocker arm retaining nuts and move rocker arms off push rods.

4. Remove push rods and place in support stand J-5709 so they can be replaced in exact position from which they were removed. (See General Information on Servicing The V-8 Engine, page 6-7). NOTE: Number seven exhaust valve push rod (rearmost on left bank) cannot be removed on cars equipped with defroster. In this case withdraw rod part way and tie or otherwise fasten rod to head.

5. Remove exhaust crossover pipe to manifold attaching screws.

6. Remove screws from cylinder head water inlet fitting.

7. Remove cylinder head screws (dowel pins will hold head in place) and remove head with exhaust manifold attached using Lifting Hooks J-4266.

CAUTION: Extreme care should be taken when handling or storing cylinder heads as the rocker arm studs are hardened and may crack if struck.

NOTE: If left head is being removed it will be necessary to raise head off dowel pins, move it forward, and "jockey" the head in order to clear the defroster, power steering, and power brake equipment.

8. Remove cylinder head gasket.

REPLACE

NOTE: Right and left cylinder heads are the same except for location of the core hole plug in end of water passage. (Figs. 6-39 and 6-40); therefore, only one head is serviced. New heads are complete with rocker arm studs, and all plugs except the one core hole plug.

When installing new head transfer all serviceable parts to new head using new seals on intake and exhaust manifold valve stems, and new exhaust manifold gasket. Install new water passage plug using gasket cement, and install new intake manifold mounting studs. Check rocker arm position with valve train gauge J-6324 (Fig. 6-21).

1. Thoroughly clean gasket surfaces of head and block, place new gasket on block, and replace cylinder head.

2. Start all screws in threads. NOTE: Screws are three different lengths. When inserted in proper holes all screws will project an equal distance from head. Do not use sealer of any kind on threads.

3. Tighten screws evenly to 95 lb. ft. torque.

4. Replace push rods in same location and with the same end up (against rocker arm) as when disassembled.

5. Reposition rocker arms and tighten rocker arm ball retaining nuts to 15 lb. ft. torque.

6. Replace rocker arm cover and tighten screws to 5 lb. ft. torque.

7. Replace push rod cover and tighten screws to 5 lb. ft. torque (page 6-11).

8. Replace battery ground strap and engine ground strap on left head or engine ground strap and Hydra-Matic oil level indicator tube bracket on right head. Also replace the engine oil level indicator on right side.

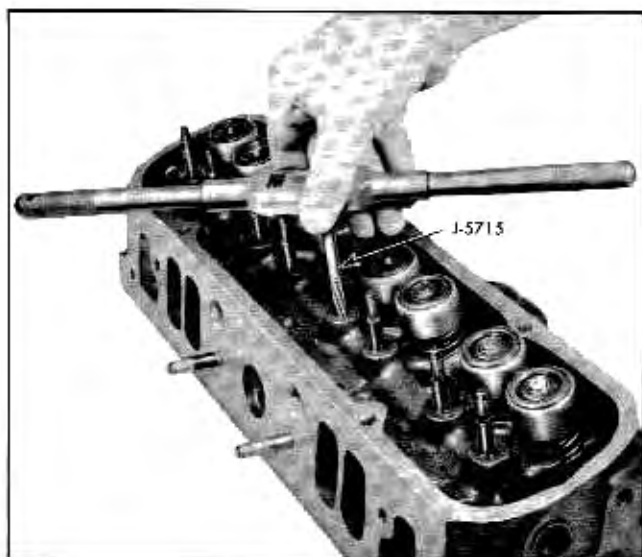

Fig. 6-17 Reaming Rocker Arm Stud Hole

9. Attach cylinder head water inlet using new gasket.

10. Replace intake manifold using new gaskets (page 6-9).

11. Install new crossover-pipe-to-exhaust-manifold gaskets and replace flange screws. NOTE: Use two thin (.075") gaskets or one thick (.135") gasket.

ROCKER ARM STUD—REMOVE AND REPLACE

(Rocker arm studs are replaceable providing a press of two tons capacity or more is available.) NOTE: Both standard and .003 oversize studs are available. If replacing stud which has become loose, ream out stud hole using reamer J-5715 (Fig. 6-17). Use .003" oversize stud and install according to steps 7 thru 19. If replacing stud because broken or because of defective thread or oil hole, use standard size stud and install according to steps 8 thru 19.

1. Remove cylinder head from engine (page 6-12).

2. With rocker arm removed, file two slots $\frac{3}{32}$ " to $\frac{1}{8}$ " deep on opposite sides of rocker arm stud (Fig. 6-18). Top of slots should be $\frac{1}{4}$ " to $\frac{3}{8}$ " below thread travel.

3. Place washer J-6392-3 at bottom of rocker arm stud.

4. Position Rocker Arm Stud Remover J-6392-1 on rocker arm stud and tighten screws securely with $\frac{5}{32}$ " allen wrench.

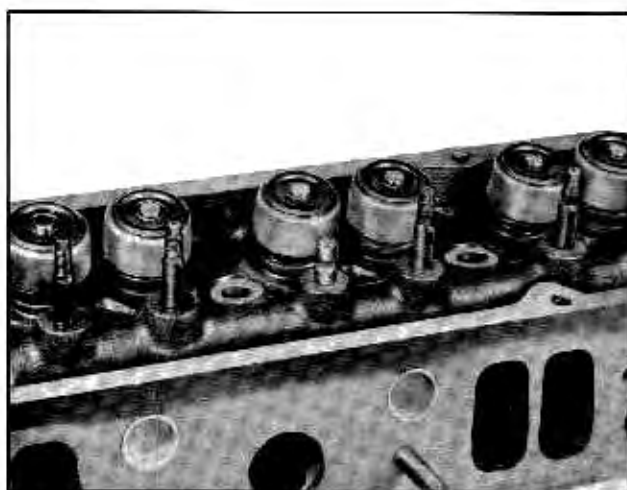

Fig. 6-18 Slots Filed in Rocker Arm Stud

5. Place spacer J-6392-2 over Stud Remover J-6392-1.

6. Thread $\frac{7}{8}$ " standard nut on stud remover and turn nut until rocker arm stud is out of cylinder head (Fig. 6-19).

7. Remove plugs (Figs. 6-39 and 6-40) from ends of cylinder head oil gallery and thoroughly clean out metal deposits and foreign matter from oil gallery (head must be right side up so foreign material will not lodge in or around studs).

8. Position rocker arm on new rocker arm stud and place Rocker Arm Stud Installer J-6301 on stud in place of rocker arm ball.

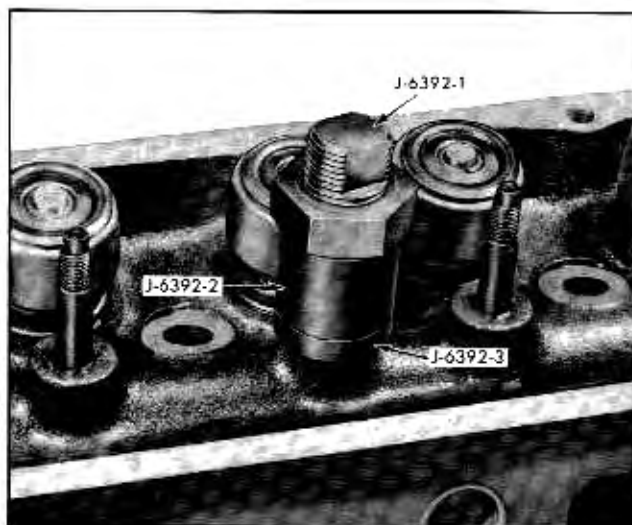

Fig. 6-19 Tool J-6392 Positioned to Remove Rocker Arm Stud

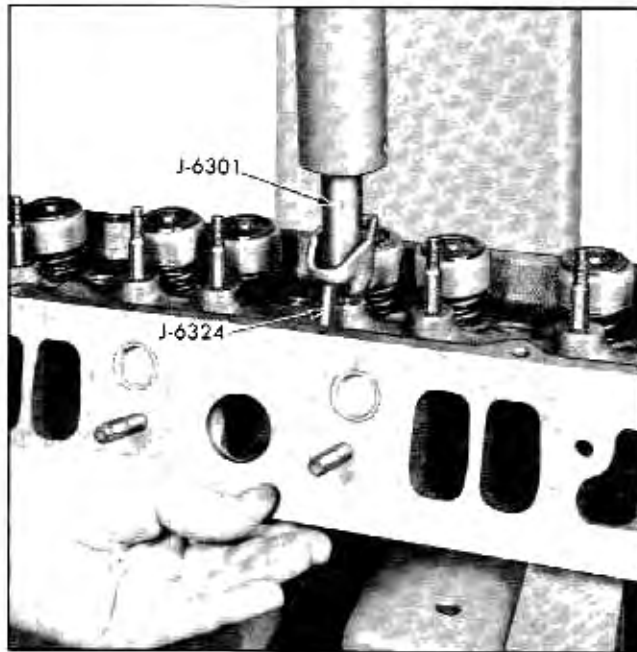

Fig. 6-20 Pressing in New Rocker Arm Stud

9. Coat rocker arm stud with white lead and oil and with cylinder head mounted in press on tool J-5712 so studs are vertical, position new stud with rocker arm and rocker arm stud installer over hole in head (Fig. 6-20).

10. Carefully press stud into head until it is in about half way ($\frac{7}{16}$ ").

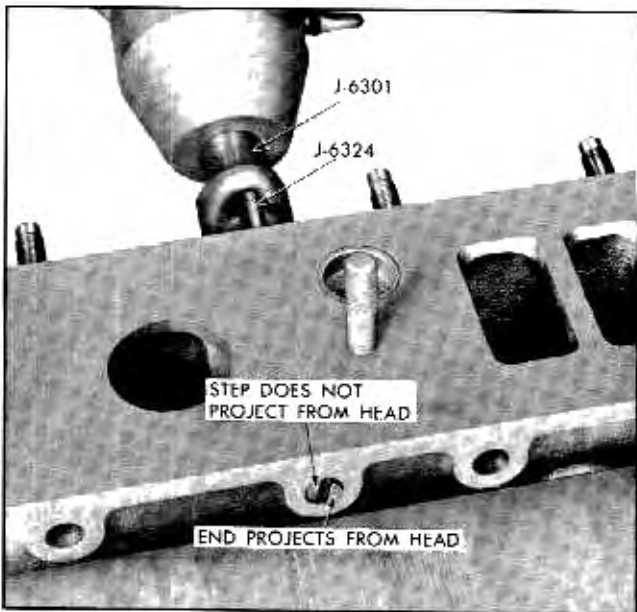

Fig. 6-21 Step of Gauge When Stud is Properly Installed

11. Position Valve Train Gauge J-6324 in push rod hole so that it seats properly in the rocker arm.

12. With valve seated, slowly press rocker arm stud into cylinder head (Fig. 6-20) until gauge projects about midway between the end of the gauge and the step with respect to the gasket surface of the cylinder head (Fig. 6-21).

13. Remove Rocker Arm Stud Installer J-6301, rocker arm and ball.

14. Blow air through hole in new stud to insure that the passage is not restricted.

15. Blow air through oil gallery to remove any foreign matter.

16. Replace plugs in ends of oil gallery (Figs. 6-39 and 6-40).

17. Check oil passages from oil gallery to all studs. (See step 3c, "Cleaning and Inspection," page 6-27.)

18. Install rocker arm and ball and install nut loosely.

19. Replace cylinder head (page 6-12).

HYDRAULIC VALVE LIFTER—REMOVE AND REPLACE REMOVE

1. Remove intake manifold (page 6-9).

2. Remove push rod cover.

3. Remove rocker arm cover.

4. Loosen rocker arm ball nut and move rocker arm off push rod.

5. Before removing lifter that is suspected of having a stuck plunger, it can be tested using Lifter Plunger Unloader J-5097. To check lifter, insert pin of unloader tool through hole in push rod seat and push down on tool. Pin will unseat ball and tool will move push rod seat and plunger down. If lifter plunger is stuck, it will be impossible to move push rod seat down.

6. Remove push rod. NOTE: Number seven exhaust valve push rod (rearmost on left bank) cannot be removed on cars equipped with defroster unit. In this case the push rod can be moved off valve lifter seat and tied or otherwise held away from lifter.

7. Remove lifter. Hydraulic Valve Lifter Remover, J-3049, may facilitate removal of lifter. NOTE: If more than one lifter is to be replaced, store push rods in Stand J-5709 and lifters in Lifter Box J-5763 so

they can be re-installed in exactly the same place and position (see General Information on Servicing The V-8 Engine, page 6-7).

REPLACE

NOTE: If new lifter is to be installed, be sure to remove all sealer coating from inside of new lifter and check leak down rate (page 6-32).

1. Place new lifter in lifter boss.
2. Replace push rod exactly as removed (same end against rocker arm).
3. Position rocker arm on push rod and tighten rocker arm ball retaining nut to 15 lb. ft. torque.
4. Replace rocker arm cover.
5. Inspect condition of push rod cover gasket and crankcase ventilator lower baffle gasket and replace if necessary; replace push rod cover and tighten screws to 10 lb. ft. torque (page 6-11).
6. Replace intake manifold (page 6-9) using new gaskets.

ENGINE INSULATORS—REMOVE AND REPLACE

FRONT INSULATOR

NOTE: If new rear insulators are also to be installed, they should be installed first since the engine locates from the rear insulators.

1. Take weight of engine off front insulator using suitable engine lifting equipment such as Support Fixture J-4732 (Do not use jack under oil pan). **CAUTION:** Disconnect battery ground strap before raising engine. When the engine is raised, the starting motor solenoid terminals may contact the steering gear which could energize the starting motor if the ground cable is not disconnected.
2. Remove screws fastening engine support to timing chain cover (Fig. 6-22).
3. Remove screws which fasten insulator to frame front cross member. These screws can be reached through an access hole in the bottom of the front cross member.
4. Raise engine just clear of insulator and support assembly.
5. Disconnect exhaust crossover pipe at left manifold and exhaust pipe and exhaust crossover pipe at right exhaust manifold connector so it can be lowered to provide clearance for removing insulator.

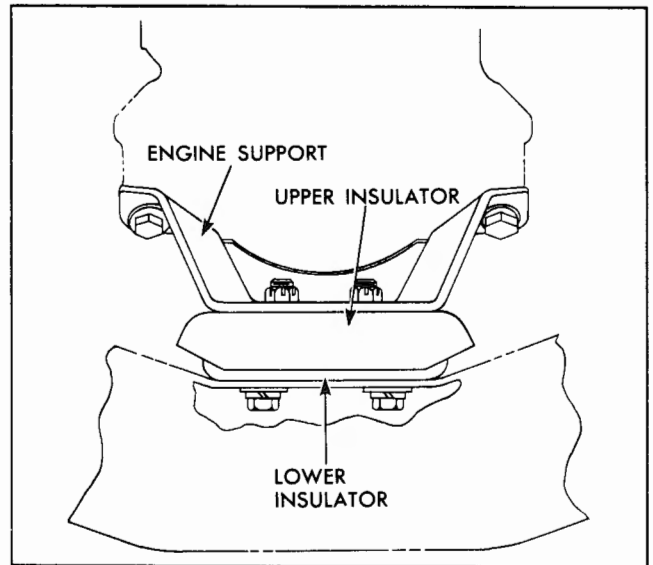

Fig. 6-22 Engine Front Insulator Mounting

6. Remove insulator and support assembly.
7. Remove retaining nuts and separate engine support from insulator assembly and separate upper insulator from lower insulator.
8. Assemble new upper and lower insulator, position engine support on top of insulator assembly, and install self locking retaining nuts.
9. Position insulator and support assembly against timing chain cover and install attaching screws with lockwashers. Tighten to 60 lb. ft. torque.
10. Connect exhaust crossover pipe to left exhaust manifolds and exhaust pipe and exhaust crossover pipe to right exhaust manifold connector using all new gaskets. Use two thin (.075") or one thick (.135") gaskets at each flange. Tighten attaching bolts securely.
11. Lower engine.
12. Install frame to insulator screws with lockwashers and tighten securely.

REAR INSULATORS

NOTE: The rear insulators locate the engine. For this reason, any time the rear insulators are replaced the front insulator must be allowed to re-position itself on the frame as is brought out in the following procedure.

1. Remove the two front insulator to frame bolts.
2. Support engine at rear to remove engine weight from rear insulators using suitable engine lifting

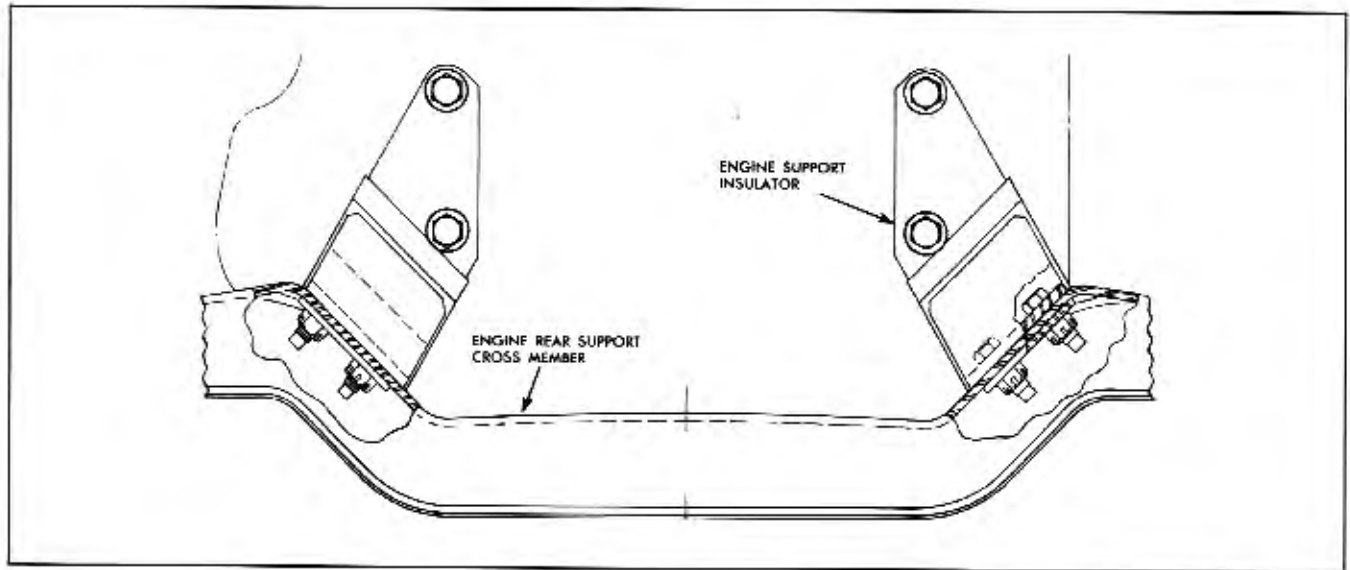

Fig. 6-23 Engine Rear Insulator Mounting

equipment such as Support Fixture J-4732 (Do not use jack under engine oil pan). **CAUTION:** Disconnect battery ground strap before raising engine. When engine is raised, the starting motor solenoid terminals may contact the steering gear which could energize the starting motor if the ground cable is not disconnected.

3. Remove two bolts holding each rear insulator to frame cross member, and then remove insulators by removing two bolts holding each insulator to flywheel housing. (Disconnect exhaust pipe from exhaust cross-over pipe so exhaust pipe can be moved to gain access to right insulator to frame bolts.)

4. Install two new insulators on flywheel housing using lockwashers under each of two bolts holding each insulator.

5. Lower engine so rear insulators are resting on frame cross member and insert insulator to frame bolts from top. Install self locking nuts (Fig. 6-23) and tighten to 35 lb. ft. torque.

6. Raise front of engine slightly to take weight off front insulator, then lower engine completely so it rests on front insulator and install two front insulator to frame bolts (with lockwasher and flat washer on each).

HARMONIC BALANCER—REMOVE AND REPLACE

1. Loosen generator at adjusting strap and remove fan belt from harmonic balancer. On cars equipped

with power steering, also remove power steering pump belt from harmonic balancer.

2. Position fan so wide angles will be at top and bottom allowing access to balancer (Fig. 6-24).

3. Remove harmonic balancer attaching bolt ($1\frac{5}{16}$ " socket) and retainer washer.

4. Remove harmonic balancer by sliding it off end of crankshaft.

5. Install new harmonic balancer by reversing above steps. **NOTE:** Be sure to install key parallel with crankshaft. Tighten harmonic balancer to 160 lb. ft. torque.

TIMING CHAIN COVER, GASKET, OIL SEAL, OR FUEL PUMP ECCENTRIC—REMOVE AND REPLACE

1. Drain radiator.



Fig. 6-24 Harmonic Balancer

2. On cars with power steering, remove pump with mounting bracket from pad on top of timing chain cover and lay back on fender skirt where it will be out of way. **CAUTION:** Before laying pump on fender skirt, disconnect battery ground strap to prevent pump from grounding "BAT" terminal of regulator.

3. Disconnect wires from generator and remove generator with mounting bracket and adjusting strap.

4. Remove fan belt and power steering pump belt.

5. Remove fan and pulley from hub of water pump.

6. Disconnect upper radiator hose from radiator and remove fan shroud.

7. Disconnect lower radiator hose and heater hose and remove radiator.

8. Remove water inlet elbows from cylinder heads (leave attached to hose).

9. Remove fuel pump (see **ENGINE FUEL** Section).

10. Remove harmonic balancer ($1\frac{5}{16}$ " socket).

11. Take weight off engine front insulator using suitable engine lifting equipment. **CAUTION:** Do not use jack under engine oil pan.

12. Remove screws and lockwashers which fasten front engine support to timing chain cover (Fig. 6-22).

13. Remove front four oil pan to timing chain cover screws.

14. Remove timing chain cover to block attaching screws and nuts.

15. Pull timing chain cover forward to clear studs and remove.

16. Remove timing chain cover gasket and thoroughly clean gasket surfaces on block and cover. Use care to prevent gasket particles and other foreign material from falling into oil pan.

17. Inspect front oil pan gasket and replace if defective. If new gasket is installed, it should be cemented to oil pan.

18. Remove timing chain cover oil seal and install new seal. Face of new seal should be coated with graphite lubricant.

19. If new fuel pump eccentric is to be installed, remove camshaft sprocket retainer screw and retainer washer and remove eccentric (Fig. 6-25). Install new eccentric, indexing pin on eccentric with hole in cam-

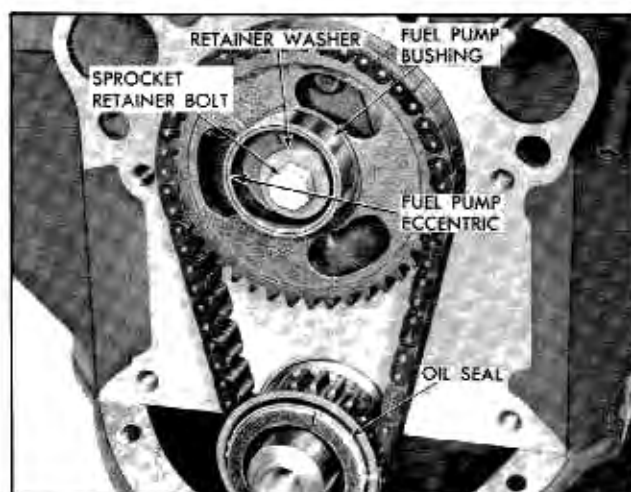

Fig. 6-25 Front of Engine with Timing Sprocket Cover Removed

shaft sprocket. Insert retainer screw with retainer washer and tighten securely. **NOTE:** Two type eccentrics which differ in appearance are used. The early type is of one piece construction, while the late type eccentric is an assembly of two piece construction using a bushing over the eccentric. The bushing is held in place by the fuel pump arm.

20. Position new timing chain cover gasket over studs against block.

21. Transfer water pump to new timing chain cover if new cover is to be installed.

22. Position timing chain cover on engine, install cap screws and nuts and tighten securely.

23. Install four oil pan to timing chain cover screws and tighten to 18 lb. ft. torque.

24. Loosely install front-engine-support-to-timing-chain-cover screws with lockwashers. Lower engine; then tighten screws to 60 lb. ft. torque.

25. Install harmonic balancer, install retainer screw with retainer, and tighten to 160 ft. lb. torque.

26. Connect water inlet elbows to cylinder heads using new gaskets. Connect lower radiator hose to pump inlet.

27. Position pulley and fan on water pump hub and install self-locking attaching screws. Tighten to 20 lb. ft. torque.

28. Install power steering pump and belt on cars so equipped.

29. Install generator with mounting bracket and belt and connect wires. Re-polarize generator by mo-

mentarily touching a jumper to "BAT" and "GEN" terminals of regulator.

30. Install fan belt and power steering pump belt and adjust both to proper tension (page 6-8 and STEERING section).

31. Install fuel pump (see ENGINE FUEL section).

32. Place fan shroud over fan and position it as far back as possible to permit radiator to be installed.

33. Install radiator.

34. Install fan shroud and connect radiator and heater hoses.

35. Refill cooling system and check for leaks.

CYLINDER BLOCK AND HEAD CORE HOLE AND OIL PASSAGE PLUG REPLACEMENT

All plugs in the block and cylinder head can be replaced with the engine in the car. The rear plugs in the block can be reached by removing the transmission, flywheel, and flywheel housing (Synchro-Mesh). In order to remove and replace water jacket plugs, it helps to lower the rear of the engine. When lowering the rear of the engine, the front insulator must be removed or it will be damaged.

REMOVING PLUGS

Rear plugs in left cylinder head can be reached through toe plate hole in floor, but right cylinder head must be removed for replacement of rear plugs. Water jacket plugs in sides of block can be reached by removing engine side aprons and engine components which are in the way. Old plugs can be removed by using a punch to knock a hole through the center of the plug and then working the plug out. Punching through the plug also serves to distort and loosen the plug. When removing cylinder head oil gallery plugs, drive punch through plug near bottom so as not to damage rocker arm stud.

Remove small oil passage plug in top of cylinder head as follows:

1. Remove rocker arm cover.
2. Insert easy-out in hole of plug turning counter-clockwise and pulling out on easy-out at same time (Fig. 6-26).

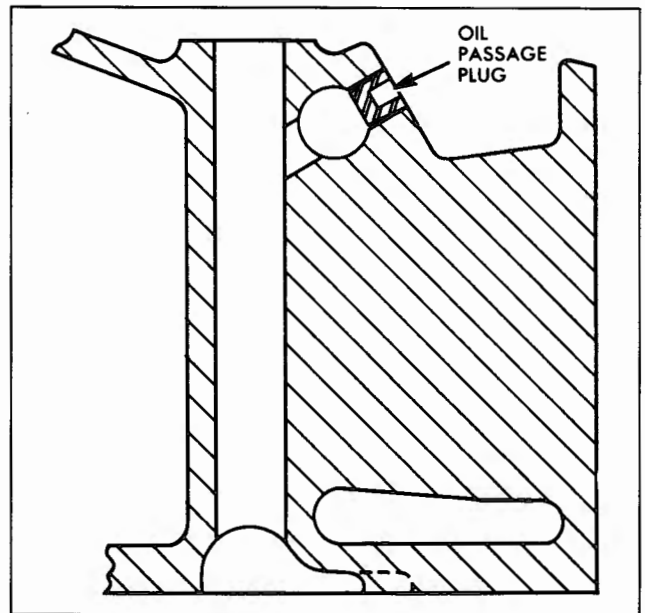

Fig. 6-26 Removing Oil Passage Plug

PREPARING HOLES AND PLUGS FOR INSTALLATION

After plug is removed, carefully clean up the hole so the new plug will seal properly. Check for sharp edges on the holes, especially when replacing the camshaft plug. Any sharp edges must be removed to prevent damaging the new plug when it is installed. All pressed-in plugs and pipe plugs should be coated with sealer before installation. G.M. Perfect Seal Gasket Paste, available through G.M.P.D. is excellent for this purpose.

INSTALLING NEW PLUGS

The following plugs can be installed by driving into place using a flat piece of metal or hard wood bearing against the outer surface: Camshaft plug, water jacket plugs, rear oil gallery plug in block, cylinder head core hole plugs, valve spring chamber plug, and the oil hole plug in the top of the cylinder head.

Front oil gallery plugs in the block, and cylinder head oil gallery plugs must be driven into place using a tool which bears against the bottom of the plug. A $\frac{1}{2}$ " x 3" bolt will make a satisfactory tool for this purpose.

All plugs should be driven in until the outer edge is flush with the surrounding surface.

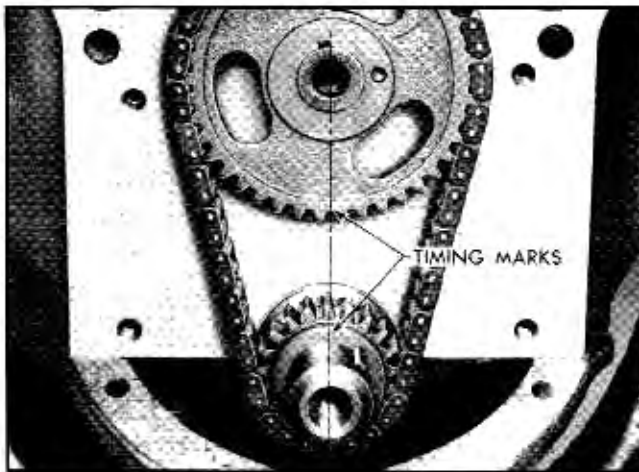
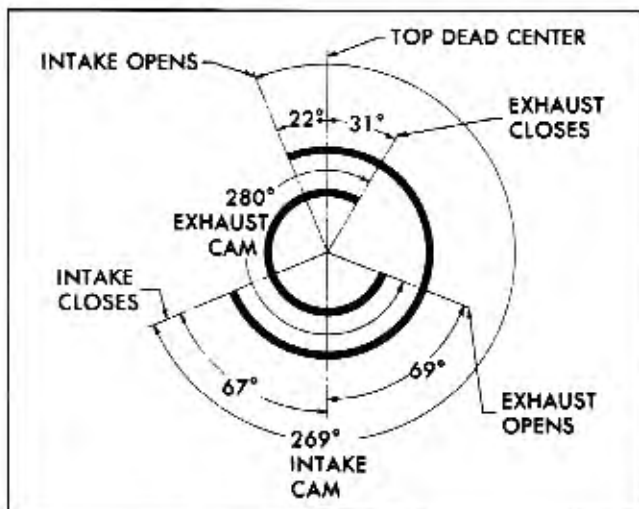
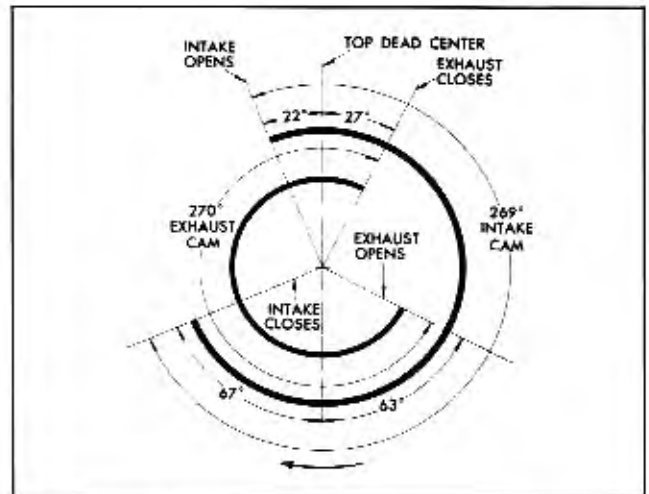

Fig. 6-27 Valve Timing Marks

TIMING CHAIN—REMOVE AND REPLACE

1. Remove radiator and timing chain cover (page 6-16).
2. Remove fuel pump eccentric and timing chain cover oil seal.
3. Align timing marks to simplify proper positioning of sprockets during reassembly (Fig. 6-27).
4. Slide timing chain and sprockets off ends of crankshaft and camshaft.
5. Install new timing chain and/or sprockets making sure marks on timing sprockets are aligned exactly on a straight line passing through the shaft centers (Fig. 6-27). Camshaft should extend through

Fig. 6-28 Valve Timing Diagram
Hydra-Matic TransmissionFig. 6-29 Valve Timing Diagram
Synchro-Mesh Transmission

sprocket so that hole in fuel pump eccentric will locate on shaft. Valve timing diagram for the engine is shown in Fig. 6-28 and Fig. 6-29.

6. Install fuel pump eccentric, indexing pin on eccentric with hole in sprocket. Install retainer screw with retainer washer and tighten securely.
7. Install timing chain cover and radiator (page 6-16).

CAMSHAFT—REMOVE AND REPLACE

1. Drain radiator.
2. Remove intake manifold (page 6-9).
3. Remove crankcase ventilator outlet pipe and push rod cover.
4. Remove rocker arm covers. Spark plug wires should be disconnected from plugs and moved out of way.
5. Loosen rocker arm ball nuts so that rocker arms can be disengaged from push rods and turned sideways.
6. Remove push rods and hydraulic lifters. Store push rods in Stand J-5709 and lifters in Lifter Box J-5763 so they can be reinstalled in original positions (see page 6-13). NOTE: Cylinder number seven exhaust valve push rod cannot be removed due to interference with defroster core. It should be blocked up, however, so that it will not interfere with removal of the camshaft (a spring loaded clothes pin can be used for this purpose).

7. Remove radiator and timing chain cover (page 6-16).

8. Remove timing chain cover oil seal and fuel pump eccentric.

9. Slide timing chain and sprockets off ends of crankshaft and camshaft.

10. Remove camshaft thrust plate attaching screws and remove thrust plate.

11. Slide camshaft out of engine very carefully, making sure not to damage bearings in block. The front of the engine should be raised as necessary to permit shaft to slide between the grill and the hood catch plate support.

12. Carefully slide new camshaft into place in block.

13. Position camshaft thrust plate over front of camshaft with oil groove facing block. Install two attaching screws with lockwashers and tighten securely.

14. Install timing chain and sprockets, making sure marks on timing sprockets are aligned exactly on a straight line passing through the shaft centers (Fig. 6-27).

15. Install fuel pump eccentric, indexing pin on eccentric with hole in sprocket. Install retainer screw with retainer washer and tighten securely.

16. Install timing chain cover and radiator (page 6-16).

17. Install hydraulic lifters and push rods in exact places and positions from which they were removed (see page 6-8).

18. Position rocker arms on push rods and valve stems and tighten rocker arm ball retaining nuts to 15 lb. ft. torque.

19. Install push rod cover and crankcase ventilator outlet pipe.

20. Install intake manifold (page 6-9).

21. Install rocker arm covers and connect spark plug wires.

22. Refill cooling system and check for leaks.

OIL PAN OR GASKETS—REMOVE AND REPLACE

1. Drain oil from crankcase.

2. Remove left and right engine side aprons.



Fig. 6-30 Rear Oil Pan Gasket Positioned in Bearing Cap



Fig. 6-31 Front Oil Pan Gaskets Overlapping Side Gaskets

3. Remove two idler lever support attaching screws and lower the steering linkage as far as possible.

4. Disconnect exhaust crossover pipe at left exhaust manifold and from exhaust pipe and exhaust crossover pipe at right exhaust manifold connector. (Universal socket must be used at connection to left manifold.) Remove pipe by "jockeying" around to a position where it will come out without forcing.

5. Remove two rear oil pan screws which retain flywheel housing front shield to cylinder block. Remove four screws which retain shield to flywheel housing and remove shield.

6. Remove flywheel housing lower cover screws and remove cover. Open end wrench must be used on two rear screws. Loosen crankcase ventilator outlet pipe brace clamp and swing brace out of way.

7. Remove oil pan screws and remove oil pan.

8. Remove oil pan gaskets from oil pan. Thoroughly clean gasket surfaces of oil pan and block.

9. Remove rear bearing cap gasket from groove in cap and thoroughly clean groove.

10. Apply Permatex No. 3 gasket cement to gasket groove from joint face down 1" to 1¼" (Fig. 6-30) and install new gasket.

11. Apply gasket cement to gasket surface of oil pan and position new gaskets on pan. Make sure front gasket overlaps side gaskets (Fig. 6-31).

12. Position oil pan on block, install attaching screws, (except two center rear screws which also retain flywheel housing front shield), and tighten to 12 lb. ft. torque

13. Position flywheel housing lower cover against bottom of flywheel housing. Start the two rear screws with lockwashers to hold the cover in place. Position clutch countershaft bracket (Synchro-Mesh only) against left side of cover and install two screws with lockwashers. Position crankcase ventilator outlet pipe brace against right side and install attaching screw with lockwasher. Install remaining screw and tighten all screws and clamp on crankcase ventilator outlet pipe.

14. Position shield against front of flywheel housing and install four shield to flywheel housing screws and two oil pan screws which retain oil pan and shield to the block. Tighten oil pan screws to 12 lb. ft. torque.

15. Install exhaust crossover pipe with new gaskets. Use two thin (.075") gaskets or one thick (.135") gasket at each flange. Tighten attaching bolts securely.

16. Position idler arm shaft against frame, install two attaching bolts, and tighten securely.

17. Install left engine side apron.

18. Refill crankcase with five quarts engine oil.

OIL PUMP—REMOVE AND REPLACE

See Engine Cooling and Lubrication section.

REAR MAIN BEARING OIL SEAL—REMOVE AND REPLACE

1. Drain oil and remove oil pan (page 6-20).
2. Remove oil pump and oil pump drive shaft.
3. Remove oil baffle and cylinder block to oil baffle tube (lower oil level indicator tube).
4. Remove transmission (section 7 for Synchro-Mesh; Hydra-Matic Shop Manual, for Hydra-Matic).
5. Remove rear center main bearing cap and upper half of rear center main bearing shell. This will

eliminate danger of damaging thrust surfaces of bearing and will also allow crankshaft to be lowered more easily. NOTE: See steps 4 and 5 under "Main Bearing — Remove and Replace," page 6-22 for method of removing upper half of bearing insert.

6. Remove rear main bearing cap and loosen remaining bearing caps sufficiently to allow crankshaft to be lowered approximately 3/8" at the rear.

7. With crankshaft lowered to provide clearance, remove upper half of rear main bearing oil seal.

8. With rear main bearing cap on bench, remove oil seal and bearing shell.

9. Install new seal in block as follows:

a. First install seal in cap with one end flush with cap and compress seal using hammer and Seal Compressor J-6528 (Fig. 6-32).

b. Remove seal from cap and install in block by slipping up over crankshaft into seal cavity of block. Insert end which was flush with cap first.

c. Install rear center main bearing cap with bearing shell and tighten to 95 lb. ft. torque to pull crankshaft up into place against seal.

d. Carefully trim both ends of seal flush with block.

10. Install a new seal in rear main bearing cap using Tool J-6528 to pack seal tightly. Be sure to pack seal tightly into groove and trim flush with cap (Fig. 6-33).

11. Install cap with shell and tighten to 120 lb. ft. torque.

12. Remove rear main bearing cap again and inspect split line between cap and block to be certain that none of the seal material has been compressed between the two. If inspection shows material between cap and block surface, scrape it off to insure proper seating of metal surfaces.

13. Clean face of rear main bearing cap with volatile type cleaner to remove all oiliness. Then apply a 1/16" diameter bead of sealer on face of the cap from packing groove to external cork groove on both sides. (Use sealer Permatex No. 3.) Reinstall cap and tighten to 120 lb. ft. torque.

14. Remove rear center main bearing cap and reinstall upper half of bearing shell. Reinstall rear center main bearing cap and tighten to 95 lb. ft. torque. Tighten remaining main bearing caps to 95 lb. ft. torque.

15. Replace transmission, oil pump, oil baffle, oil pan and flywheel housing lower cover and shield.

CONNECTING ROD BEARINGS—REMOVE AND REPLACE

1. Drain oil and remove oil pan (page 6-20).
2. To gain access to numbers 5, 6, 7 or 8 connecting rod caps it will be necessary to remove oil pump screen and oil baffle.
3. Rotate crankshaft as necessary to bring crank pin carrying bearing to be replaced straight down.
4. Remove bearing cap of bearing to be replaced.
5. Install Connecting Rod Bolt Guide Set J-5239 on connecting rod bolts (Fig. 6-37).
6. Push piston and rod assembly up far enough to allow removal of bearing shell. Remove bearing shells from rod and cap.
7. Inspect crank pin for damage, out-of-round, and taper.
8. Reassemble cap and rod with new bearing shells and check fit using plastigage or shim stock as outlined on page 6-45.
9. Replace oil baffle and oil pump screen if they were removed.
10. Replace oil pan using new gaskets and fill with engine oil.

MAIN BEARINGS—REMOVE AND REPLACE

1. Drain oil and remove oil pan (page 6-20).
2. To gain access to rear center bearing cap, remove oil baffle. To gain access to rear main, remove oil pump in addition to oil baffle.
3. Remove bearing cap of main bearing to be replaced.
4. Make a tool for removing upper half of bearing shell as shown in Fig. 6-34.
5. Insert tool in oil hole of crankshaft and rotate crankshaft in usual direction of rotation. This will cause bearing to be moved from between shaft and bearing seat.
6. Oil bearing surface of shell and install by inserting plain end of bearing shell at indented side of bearing seat and gently rotating shell into place by turning shaft.
7. Install new bearing lower half by inserting in bearing cap so indentation in shell and cap coincide.

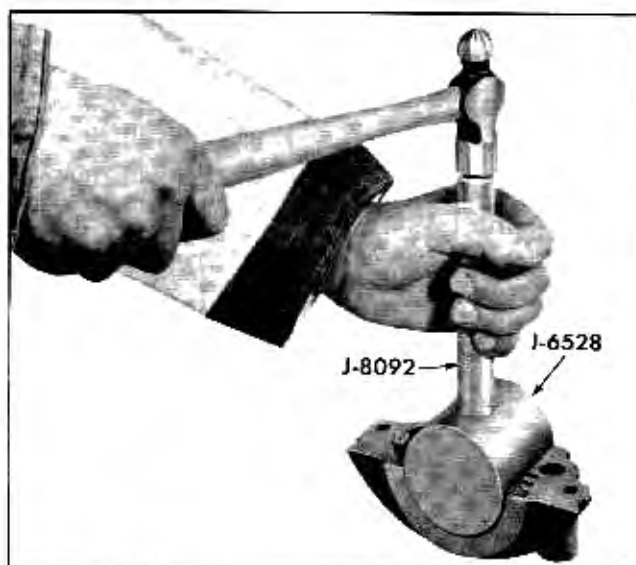

Fig. 6-32 Compressing Upper Seal in Bearing Cap

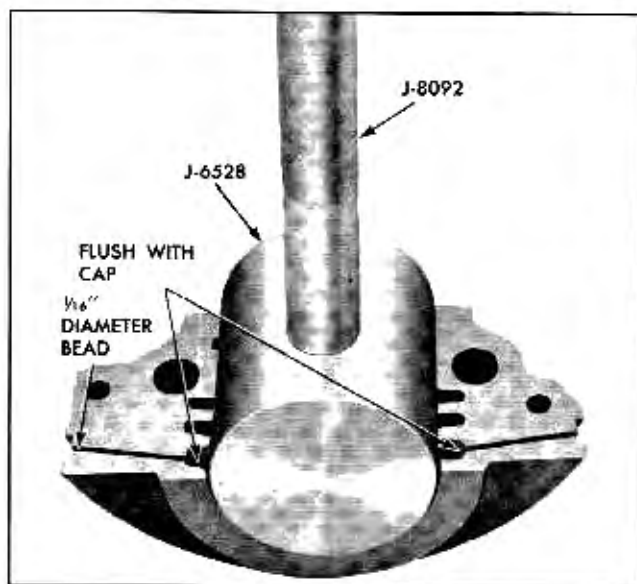

Fig. 6-33 Lower Seal Installed in Bearing Cap

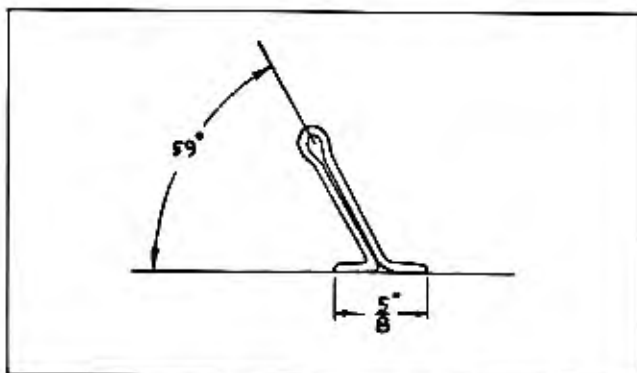

Fig. 6-34 Tool for Removing Upper Half of Main Bearing

8. Install bearing cap and check fit of bearing using plastigage or shim stock as outlined on page 6-44.

9. Replace oil pump, cylinder-block-to-oil-baffle tube, and oil baffle if they were previously removed.

10. Replace oil pan using new gaskets and fill crankcase with oil.

CONNECTING ROD AND PISTON ASSEMBLY— REMOVE AND REPLACE

REMOVE

1. Drain water from radiator and block and drain oil.

2. Remove intake manifold and cylinder head on bank from which piston is to be removed (page 6-12).

3. Remove oil pan and if number 5, 6, 7, or 8 rod and piston assembly is to be removed, remove oil baffle and oil pump screen.

4. Rotate crankshaft so crank pin carrying assembly to be replaced projects straight downward (Fig. 6-36).

5. Remove bearing cap and install Connecting Rod Bolt Guide Set J-5239 (Fig. 6-37).

6. Carefully remove connecting rod and piston assembly by pushing out with knurled handle of long guide (J-5239).

REPLACE

1. Install connecting rod bolt guide set on connecting rod bolts with long handle guide on same side as oil groove in rod.

2. Using suitable ring compressor insert piston and connecting rod assembly into cylinder so that "F" on web and notch in top of piston are toward front of engine. This will place the oil groove of the connecting rod so that it will direct oil against the opposite cylinder wall.

3. From beneath engine, pull connecting rod, with bearing shell in place, into position against crank pin.

4. Remove guide set J-5239. Install bearing cap and cap nuts and tighten to 45 lb. ft. torque.

5. Replace oil pump screen and oil baffle, if they were removed.

6. Replace oil pan using new gaskets. Tighten oil pan screws to 18 lb. ft. torque.

7. Install cylinder head and intake manifold (page 6-12).

8. Refill crankcase and cooling system, and check for leaks.

FLYWHEEL OR CLUTCH PILOT BEARING— REMOVE AND REPLACE

NOTE: See Hydra-Matic Shop Manual for replacement of flywheel on Hydra-Matic models.

1. Remove transmission (section 7 for Synchro-Mesh, see Hydra-Matic Manual for Hydra-Matic transmission).

2. Remove clutch assembly.

3. If clutch pilot bearing is to be replaced, use cold chisel to remove staking in end of crankshaft which keeps bearing in place when transmission is removed (Fig. 6-35). Remove clutch pilot bearing from hole in crankshaft.

If bearing is a snug fit in crankshaft, use puller J-4383 and Slide Hammer J-2619-A or J-942 to remove bearing. When installing new bearing see that hole in crankshaft is thoroughly clean. Install new bearing with shielded side toward transmission. Start bearing into hole and tap into place by using Clutch Pilot Bearing Installer J-5736 against outer race. Stake slightly as shown in Fig. 6-35, to keep bearing in place in case transmission is removed in the future.

4. If flywheel is to be removed and reinstalled, scribe marks on flywheel and crankshaft flange and remove flywheel to crankshaft bolts and remove flywheel. When reinstalling clean the mating flanges of flywheel and crankshaft carefully making sure there are no burrs on either mounting face. Position flywheel on crankshaft flange with scribe marks in alignment and install flywheel to crankshaft bolts and

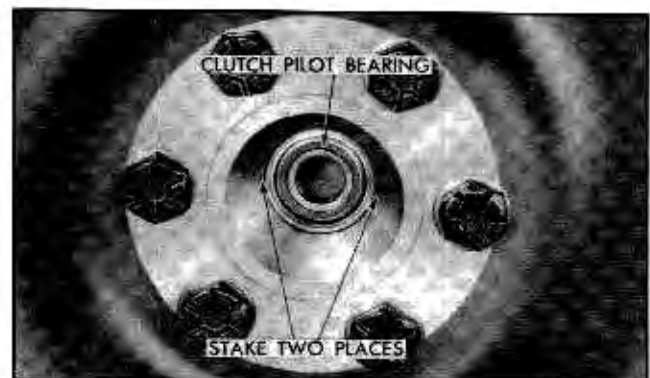

Fig. 6-35 Staking to Retain Clutch Pilot Bearing

tighten evenly to 95 lb. ft. torque. NOTE: Flywheel bolts do not require lock washers.

5. Install clutch.
6. Install transmission.

FUEL PUMP—REMOVE AND REPLACE

See Engine Fuel Section, page 6B-1.

ENGINE REMOVAL

NOTE: The engine may be removed from the car with the transmission attached; however, if it is desired to remove the transmission before removing the engine, the procedure given below will still largely apply.

1. Drain water, engine oil, and transmission lubricant.
2. Remove hood (see Chassis Sheet Metal Section, page 11-1).
3. Remove battery.
4. Remove air cleaner and disconnect throttle linkage. On cars equipped with Hydra-Matic transmission disconnect intermediate rod from carburetor throttle rod bracket, and disconnect cross shaft bracket from flywheel housing.
5. On cars with power steering, remove power steering pump belt and pump with mounting bracket, leaving hoses connected. Place pump in a position where it will not become damaged when engine is removed.
6. Remove upper and lower radiator hose and disconnect heater line from intake manifold and bottom of radiator. On Hydra-Matic equipped cars remove inlet and outlet oil lines from radiator.
7. Disconnect flex fuel line at fuel pump, oil pressure gauge line at connector near dash, and windshield wiper vacuum hose at rear of engine.
8. Disconnect power brake vacuum hose at check valve to carburetor pipe.
9. Remove terminal from thermogauge unit on intake manifold. Disconnect coil primary lead at coil. Disconnect generator to regulator wires from generator, release from clips retaining to valve cover and pull clear of engine.
10. Disconnect wire loom running to right headlamp across radiator at junction block on right side

of radiator support to fender brace and release from clips retaining to radiator.

11. Remove fan, fan shroud, and radiator.
12. Remove crankcase ventilator outlet pipe.
13. Disconnect exhaust pipe from exhaust cross-over pipe.
14. Disconnect solenoid wire loom from junction block on fender skirt.
15. Remove gearshift manual linkage at transmission.
16. Disconnect linkage from clutch release fork and remove clutch control countershaft bracket from flywheel housing (Synchro-Mesh equipped cars).
17. Remove propeller shaft.
18. Hook a chain fall to the intake manifold by means of a strong chain threaded through the openings in the manifold just behind the carburetor. Raise engine just enough to take weight off engine insulators.
19. Remove screws holding front and rear insulators to frame cross members.
20. On Hydra-Matic equipped cars, support bottom of transmission with special automatic transmission jack and remove frame cross member to which engine rear insulators were fastened. CAUTION: Use care to prevent transmission swinging down when cross member is removed, as possible damage to transmission or personal injury may result.
21. Carefully hoist engine and transmission out of car checking frequently to see that sufficient clearance exists to prevent bending any parts; this is especially important in the case of Hydra-Matic throttle linkage.

ENGINE OVERHAUL ENGINE DISASSEMBLY

(With transmission and clutch removed and engine mounted in holding stand)

1. Remove carburetor air cleaner and oil level indicator.
2. Remove generator, with mounting bracket, and fan belt.
3. Remove fan and pulley.
4. Remove generator adjusting brace.

5. Remove distributor assembly with spark plug wires and spark plug wire supports as follows:

a. Remove vacuum pipe from distributor and carburetor.

b. Remove high tension lead and primary wires from coil.

c. Remove wires from spark plugs and remove retaining screws from spark plug wire supports.

d. Remove distributor hold down clamp (special screw).

e. Remove distributor (turn slightly to right while pulling out).

6. Remove crankcase ventilator outlet pipe brackets from cylinder head and flywheel housing. Pull pipe out of flange on valve push rod cover assembly. (Push neoprene seal up on pipe so it will not be lost.)

7. Remove coil.

8. Remove fuel and vacuum pipes (pipes do not have flared fittings) and choke heat suction tube.

9. Remove throttle linkage with idler bracket.

10. Remove carburetor and gasket.

11. Remove fuel pump.

12. Remove oil filter and gasket.

13. Remove spark plugs.

14. Remove rocker arm covers.

15. Remove exhaust crossover pipe.

16. Remove right and left hand exhaust manifolds.

17. Disconnect cylinder head water outlets from each cylinder head.

18. Remove intake manifold and gaskets.

19. Remove valve push rod cover assembly with gaskets.

20. Remove rocker arm nuts and remove rocker arms with balls and place in Valve and Valve Train Holding Stand J-5709 (Fig. 6-14). NOTE: Valve lifters, push rods, rocker arms, rocker arm balls, and retaining nuts must be kept in sets when removed and each set must be replaced in the exact locations from which they were removed (see General Information on Servicing V-8 Engine, page 6-7).

21. Remove push rods and place in Support Stand J-5709.

22. Remove valve lifters. Place lifters in Valve Lifter Box J-5763 (Fig. 6-13) so lifters can be installed in the bosses from which they were removed (see General Information on Servicing The V-8 Engine, page 6-7).

23. Remove cylinder head screws and remove cylinder heads and gaskets. NOTE: Locating pins in cylinder block will hold cylinder head in position when all screws have been removed.

24. Scrape carbon from upper edge of bore. This will usually eliminate the ridge making the use of a ridge reamer unnecessary.

25. Turn engine over and remove flywheel housing front shield and oil pan.

26. Remove oil pump with floating screen and oil pump drive shaft.

27. Remove engine oil baffle and cylinder block to oil baffle tube.

28. Remove connecting rod and piston assemblies in pairs as follows: NOTE: Mark each rod and cap with the corresponding cylinder number to ensure that they will be returned to the same place when re-installed.

a. Turn crankshaft so that two opposite pistons are near bottom of stroke (Fig. 6-36). This will put crankpin on center line of block and expose rod nuts most advantageously. NOTE: Crankshaft can be turned by using a $1\frac{5}{16}$ " socket and handle on harmonic balancer attaching screw.

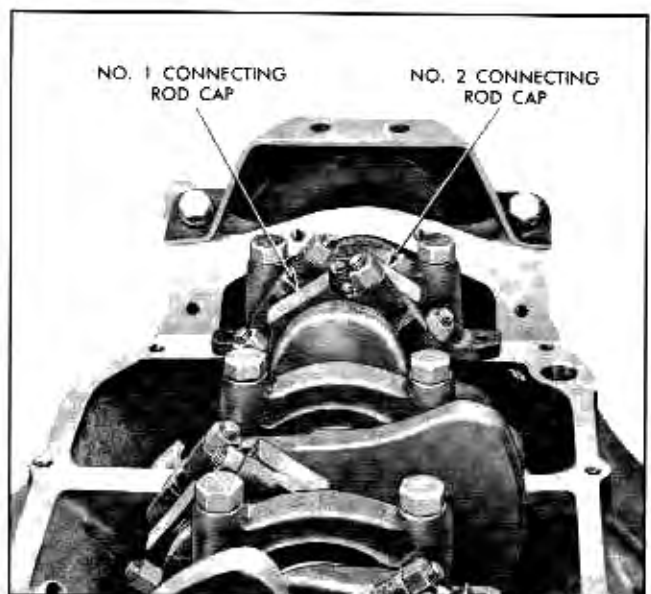

Fig. 6-36 Crankshaft Positioned for Removal of No. 1 and 2 Connecting Rod Caps

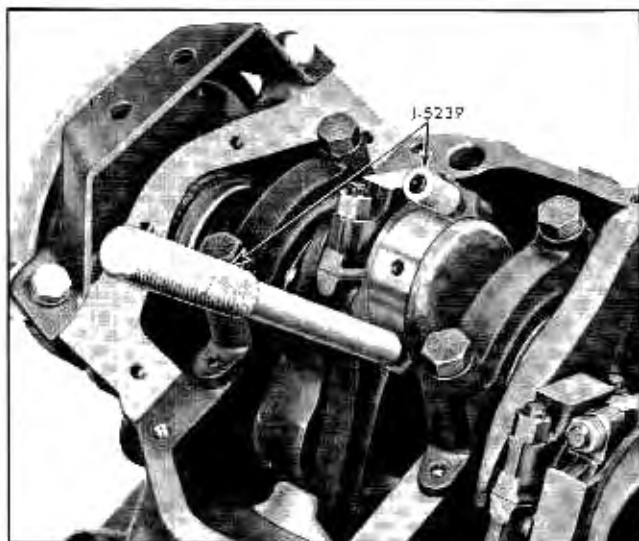

Fig. 6-37 Removing Connecting Rod and Piston Assembly

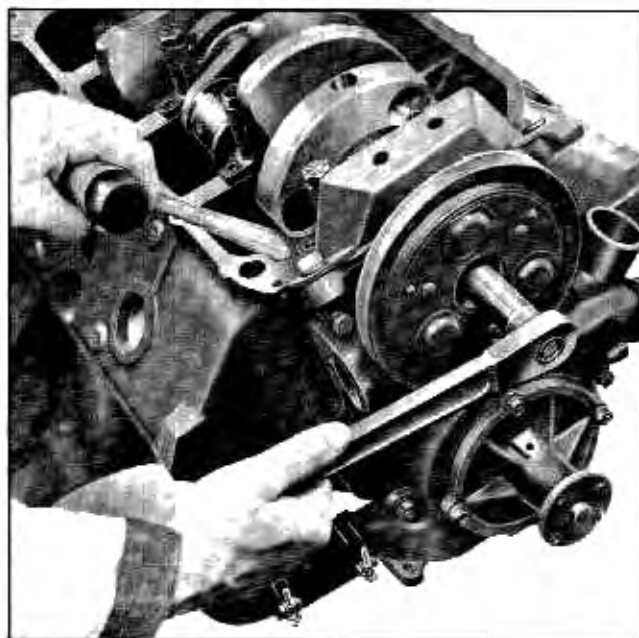

Fig. 6-38 Holding Crankshaft to Remove Harmonic Balancer

b. Remove rod nuts and bearing cap with bearing shell.

c. Install Connecting Rod Bolt Guide Set J-5239 on connecting rod bolts (Fig. 6-37).

d. Apply force on tool J-5239 and force piston out of cylinder bore.

e. Reinstall bearing cap on connecting rod to keep mating parts together.

29. Remove harmonic balancer attaching bolt and washer, and slide balancer off crankshaft. A hammer handle placed between the block and the front counterweight of the crankshaft will hold the crankshaft while attaching screw is being removed (Fig. 6-38).

30. Remove timing chain cover, timing chain cover oil seal, and timing-chain-cover-to-block gasket.

31. Remove fuel pump eccentric from camshaft. Place hammer handle between block and front crankshaft counterweight to hold crankshaft (Fig. 6-38).

32. Slide timing sprockets and timing chain off ends of crankshaft and camshaft.

33. Remove camshaft thrust plate attaching screws and remove thrust plate.

34. Remove camshaft from block, using care to prevent damage to bearings from cam lobes and oil pump and distributor drive gear.

35. Remove all main bearing caps. **NOTE:** All caps are held in positive alignment by dowel pins, which also aid in correctly installing the caps. Bearing caps should be kept in order as they are removed to avoid the possibility of interchanging caps when they are replaced.

36. Lift crankshaft from block using care to prevent damage to bearing shells.

37. Remove bearing shells from block.

38. Remove rear main bearing oil seal packing.

39. Remove drain cocks from either side of cylinder block.

CYLINDER HEAD AND VALVES —OVERHAUL

CYLINDER HEADS AND VALVES—DISASSEMBLE

1. Remove valve spring retainer cup locks (keepers), valve stem oil seals, valve spring retainer cups, valve stem shields, valve springs, and valves, using Valve Spring Compressor J-6384. Valve stem oil seals must be discarded and replaced with new seals anytime they are removed. Place valves in Valve and Valve Train Holding Stand J-5709 (Fig. 6-14).

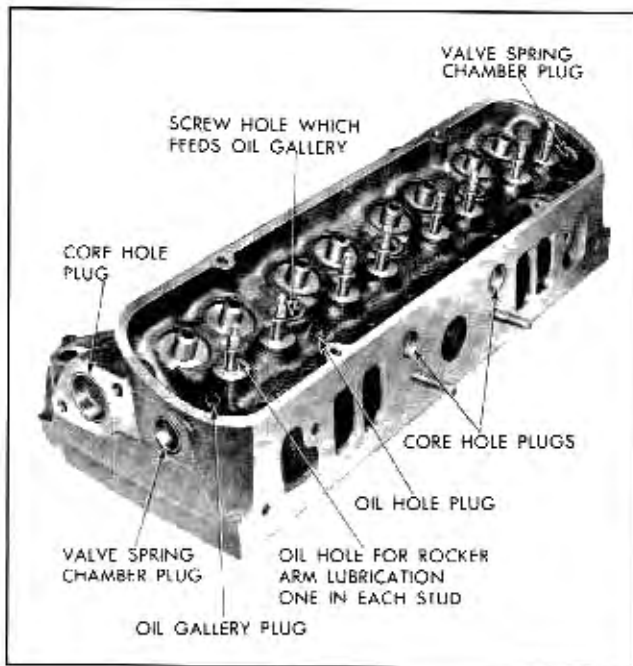

Fig. 6-39 Left Cylinder Head—Viewed from Right Rear

2. Remove cylinder head water inlet tube.

CYLINDER HEAD AND VALVES—CLEAN AND INSPECT

1. Inspect valves and seats to determine condition before cleaning. Also check oil and water passage plugs for evidence of leakage (Figs. 6-39 and 6-40).
2. Clean valves thoroughly to remove deposits from head and stem.

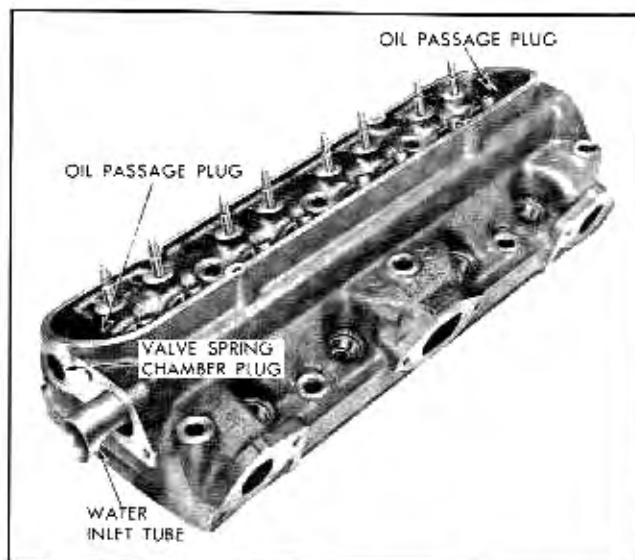

Fig. 6-40 Left Cylinder Head—Viewed from Left Front

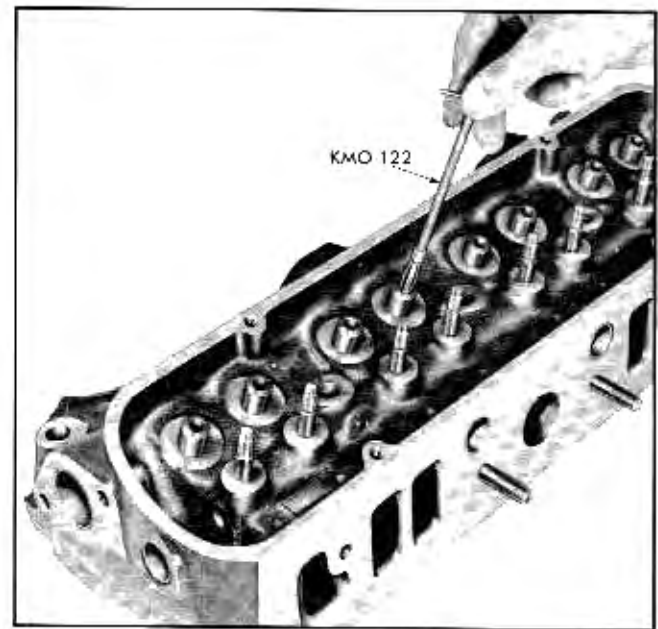

Fig. 6-41 Cleaning Valve Guide

3. Clean and inspect cylinder head as follows:

- a. Clean carbon deposits from combustion chambers and all sludge or foreign matter from other areas of cylinder head. If a scraper or wire brush is used for cleaning, use care to prevent damage to valve seats. **CAUTION:** To prevent damage to valve seat it is good practice to keep wire brush well away from seat.

- b. Clean cylinder head thoroughly using suitable cleaning equipment.

- c. Check oil passages from oil gallery through rocker arm studs. A simple test can be made using a rubber hose and smoke. Block lower end of cylinder head screw hole which feeds oil gallery (Fig. 6-39) and blow smoke in top end of hole through rubber hose. Smoke should come out hole in each stud.

4. Inspect general condition of water inlet tube.

5. Clean valve guides thoroughly using Valve Guide Cleaner KMO-122 (Fig. 6-41).

6. Visually inspect valve guides for evidence of wear, especially the end toward the spring seat. If a guide is scored or galled, install valve with proper oversize stem according to procedure on page 6-29.

7. Clean valve springs and inspect to see that they meet specifications (page 6-51).

8. Clean push rods and thoroughly clean out oil

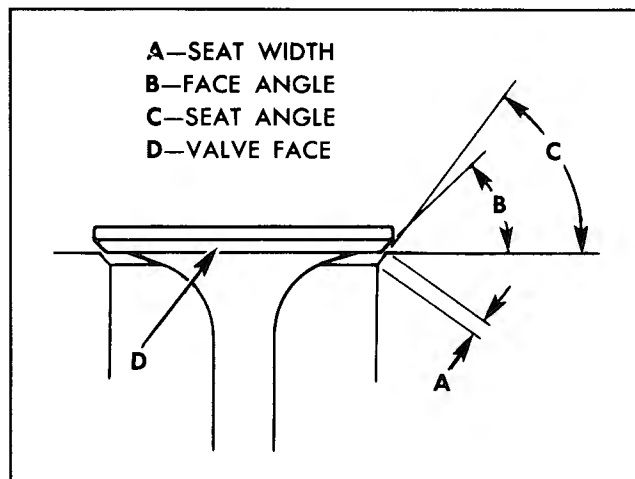

Fig. 6-42 Valve Face and Seat Angles

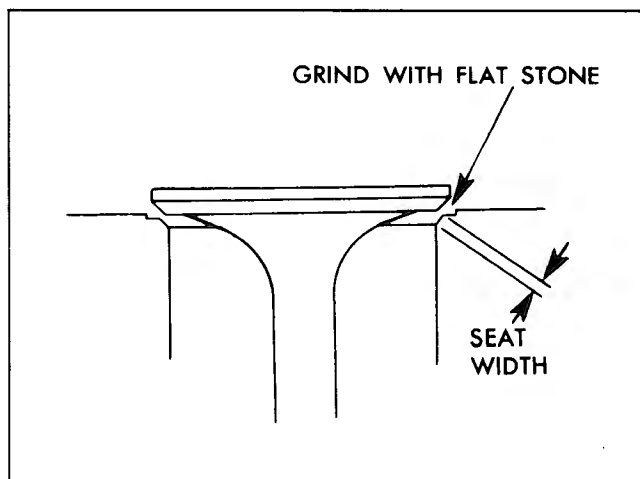

Fig. 6-43 Valve Seat after Grinding with Flat Stone

passage through center of rod. Inspect to see that the rod is straight.

9. Clean rocker arms and rocker arm balls, and visually inspect for evidence of wear.

10. Clean spark plugs as outlined in section 12.

11. Clean and inspect valve lifters as outlined on page 6-31.

VALVES AND SEATS—RECONDITION

1. Reface valves and seats as follows:

Valves should be ground on a special bench grinder designed specifically for this purpose and built by a reputable manufacturer. Valve seats should be ground with reputable power grinding equipment having stones of the correct seat angle and a suitable pilot which pilots in the tapered (.0012"-.0015" per inch) valve stem guide. To ensure positive sealing of the valve face to its seat, the grinding stones should be carefully refaced before any grinding is done. Intake valve seat angle is 30° , exhaust valve seat angle is 45° . Intake valve face angle is 29° and exhaust valve face angle is 44° . This will provide hairline contact between valve and seat to provide positive sealing and reduce build-up of deposits on seating surfaces (Fig. 6-42).

Do not use refacing equipment excessively; only enough material should be removed to true up surfaces and remove pits. The valve head will run hotter as its thickness is diminished; therefore, if valve face cannot be cleaned up without grinding to point where outside diameter of valve head has a sharp

edge, the valve should be replaced. Whenever it is necessary to replace a valve, the new valve should be of the same stem diameter as the valve removed (unless the valve guide is reamed to provide proper fit).

Width of exhaust valve seats should $\frac{1}{16}$ " (.048-.070). Intake valve seat should be between $\frac{3}{64}$ " and $\frac{1}{16}$ " (.045-.071). If seat width is excessive it should be narrowed by grinding with a flat stone (Fig. 6-43). This is the only method that should be used to narrow the seat. **NOTE:** Lapping of valve seats is not required or recommended.

2. Check concentricity of valve seat and valve guide. Concentricity of valve seat and valve guide can be checked by using a suitable dial indicator or prussian blue. When using a dial indicator, total runout should not exceed .002".

When prussian blue is used, a light coat should be applied to the face of the valve only and the valve rotated in its seat. If blue appears all the way around the valve seat, the valve seat and the valve guide are concentric with one another.

3. Check concentricity of valve stem and face of valve. After cleaning prussian blue from valve and seat from preceding check, lightly coat valve seat with prussian blue and rotate valve in guide. If blue appears all the way round the valve, the valve stem and valve face are concentric with one another. **NOTE:** Both tests in steps 2 and 3 are necessary to insure proper valve seating.

4. Check and correct length of valve stem using Valve Train Gauge J-6324 as follows:



Fig. 6-44 Checking Length of Valve Stem

a. Position rocker arm on stud and hold in place using Rocker Arm Stud Installer J-6301. Slip valve into place and hold it against valve seat. While holding rocker arm and valve in position securely, insert Valve Train Gauge J-6324 through push rod hole and seat snugly in push rod seat of rocker arm (Fig. 6-44). With all parts seated, step end of gauge should be at least flush with gasket face of head, but should not project past the step on the gauge.

b. If gauge projects too far, indicating that the valve stem is too long, grind the tip of the valve stem as necessary to make the gauge index properly. **CAUTION:** When grinding valve stem be very careful not to overheat it. Overheating will soften the hardened stem causing rapid wear.

FITTING VALVES TO GUIDES

Correct valve stem clearance for valve guides is .001" to .0027" for the intake valve and .0015" to .0032" for the exhaust valve.

Valves with oversize stems are available in .001", .003" and .005" larger than standard. The same valve stem to guide clearance applies for oversize stems.

Oversize reamers are required to enlarge valve guide holes to fit the oversize stems. When the reamer

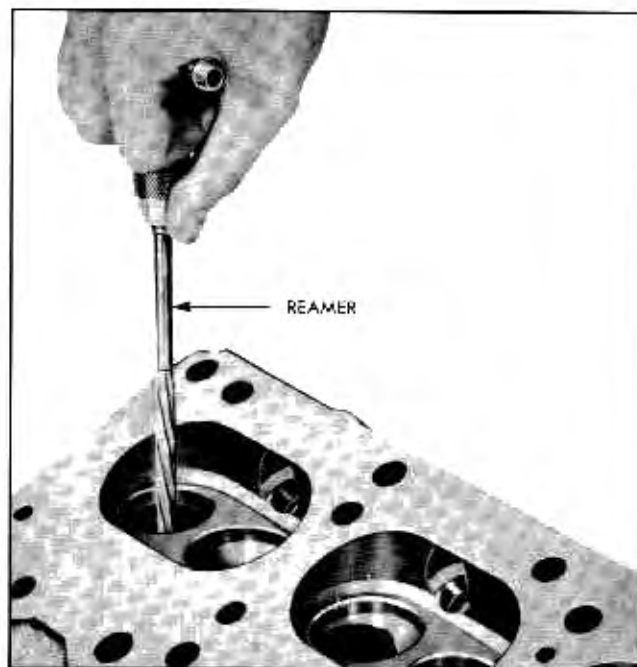

Fig. 6-45 Fitting Valves to Guides

is turned through the valve guide it will size the hole to fit the valve stem according to the above limits.

Carefully ream the valve guide using Valve Guide Reamer J-5830-1 for .003" oversize stems and Valve Guide Reamer J-6621 for .005" oversize stems (Fig. 6-45). For best results when installing .005" oversize valve stem use the .003" oversize reamer first and then ream to .005" oversize. Always reface the valve and valve seat after reaming valve guide. **NOTE:** Identification of valve stem sizes are as follows: Yellow ink on top of valve head for .001" oversize. Red ink on top of valve head for .003" oversize, and White ink on top of valve head for .005" oversize.

CYLINDER HEAD AND VALVES—ASSEMBLE

1. Install cylinder head water inlet tube with holes facing toward valve seats.

2. Install valves, valve springs, valve stem shields, valve spring retainer cups, valve stem seals and retainer cup locks using suitable spring compressor. The valve stem seals must be installed in the second groove (from end of stem). Valve Stem Seal Installer and Tester J-5751 can be used to install this seal (Fig. 6-46).

After the valves have been installed, the suction cup end of special tool J-5751 should be used to test for leaks between the valve spring retainer cup and

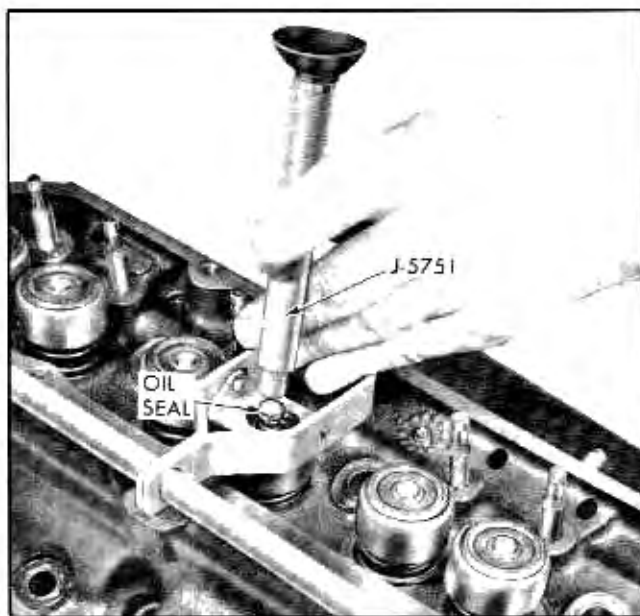

Fig. 6-46 Installing Intake Valve Stem Seal

valve stem seal (Fig. 6-47). The suction cup will tend to be held to the valve spring retainer cup by suction when the seal is satisfactory. If a leak is detected, replace seal or valve spring retainer cup as necessary. It is important to have a positive seal between the valve spring retainer cup and the valve stem seal to prevent excessive amounts of oil from being drawn down the valve stem which will cause exhaust smoke and oil consumption.

3. Install spark plugs.

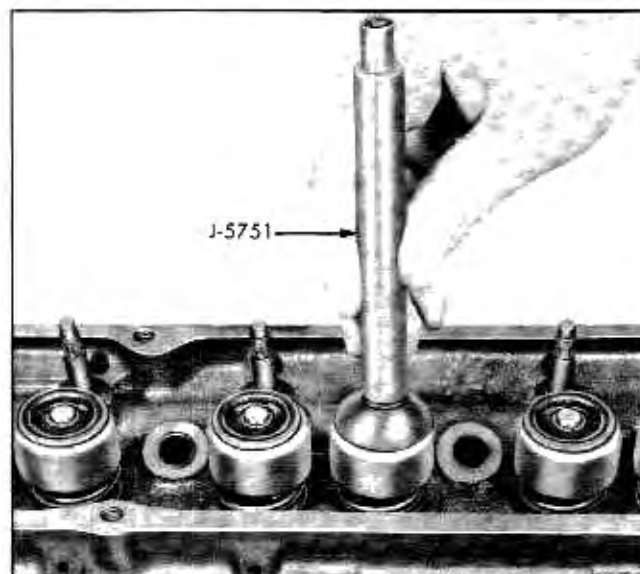

Fig. 6-47 Checking Intake Valve Stem Seal

HYDRAULIC VALVE LIFTER SERVICE

NOTE: Because of the important part hydraulic valve lifters play in the operation of an engine and the close tolerances to which they are manufactured, proper handling, and above all *cleanliness*, cannot be overstressed when servicing these parts.

Lifters should at all times be stored in a covered box (Fig. 6-13) which will aid in keeping them clean. The lifter box should be kept dry and as free of oil as possible.

New lifters are serviced as individual units packaged with a plastic coating. Leave the coating on until ready to check leakdown rate. It is not necessary to remove the oil from new lifters prior to checking leakdown rate since special leakdown oil is already in new lifters.

Wash Tank and Tray J-5821 is recommended for cleaning valve lifters. This tank should be used only for valve lifters and should be kept covered when not in use. All servicing should be done in an area removed from grinders or other sources of dust and foreign material.

VALVE LIFTER—DISASSEMBLE

1. Remove push rod seat retainer ring by holding seat down with push rod while dislodging spring from lifter body with a pointed tool (Fig. 6-48). **NOTE:** It may be necessary to unseat lifter ball, using plunger unloader J-5097, before plunger can be pushed down.

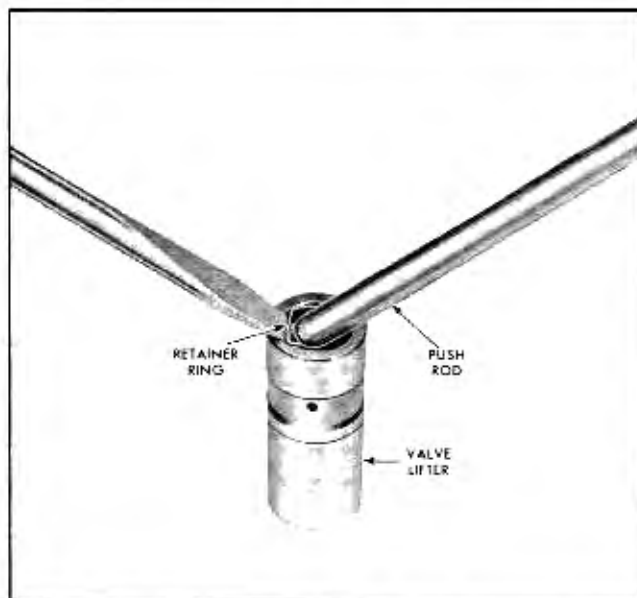

Fig. 6-48 Removing Push Rod Seat Retainer Ring

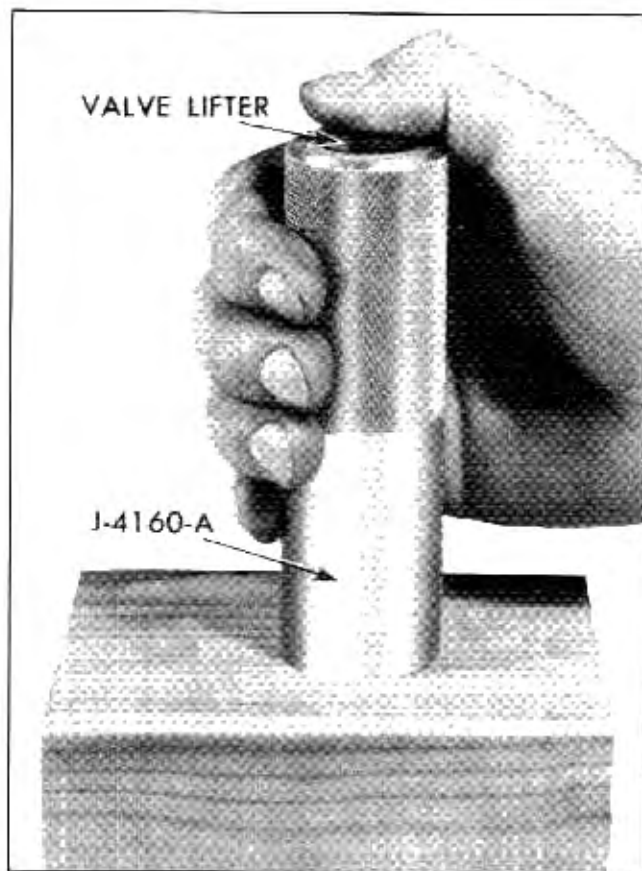

Fig. 6-49 Removing Stuck Plunger

2. Invert lifter and allow push rod seat and plunger to slide out of body. If plunger sticks in body, place lifter in large end of Hydraulic Valve Lifter Plunger Remover, J-4160-A, with push rod end of lifter downward. Hold tool firmly in hand with thumb over lifter body and sharply strike the tool against a block of wood (Fig. 6-49) until plunger falls out. **NOTE:** It may be necessary to soak a lifter having a stuck plunger in cleaning solvent for several minutes in order to remove the plunger.

3. Drain oil out of lifter body and place all valve lifter parts in separate compartment of tray from Wash Tank J-5821 (Fig. 6-50). **CAUTION:** Valve lifter body and plunger are selectively fitted and must not be interchanged with parts of other lifters. (Keeping all parts of lifters together will also aid in trouble diagnosis. See "Note", step 20 of "Engine Disassembly", page 6-25.)



Fig. 6-50 Lifter Wash Tank and Tray J-5821

VALVE LIFTER—CLEAN AND INSPECT

Wash Tank J-5821 is recommend for cleaning valve lifter parts. This tank consists of two chambers, a tray and a cover. One chamber is for cleaning solvent (Gulf Motor Flush, Bendix Cleaner, or equivalent) and the other is for kerosene. Whenever the tank is not being used (and when parts are soaking), the cover should be closed.

1. Before placing tray of parts in cleaning solvent, first immerse it in kerosene chamber to remove as much engine oil as possible. (This reduces contamination of solvent, thus prolonging its useful life.)

2. Submerge tray in cleaning solvent and allow to soak for approximately one hour. More time may be required depending on varnish condition and effectiveness of solvent. Light agitation of tray in solvent at 10-15 minute intervals will hasten cleaning action.

3. After varnish has dissolved or has been sufficiently softened to permit removal by wiping, suspend tray above solvent, utilizing hooks on tray handles. Allow tray and parts to drain for a brief period.

4. Rinse tray of parts in kerosene chamber to cut solvent and to avoid injury to hands (from solvent).

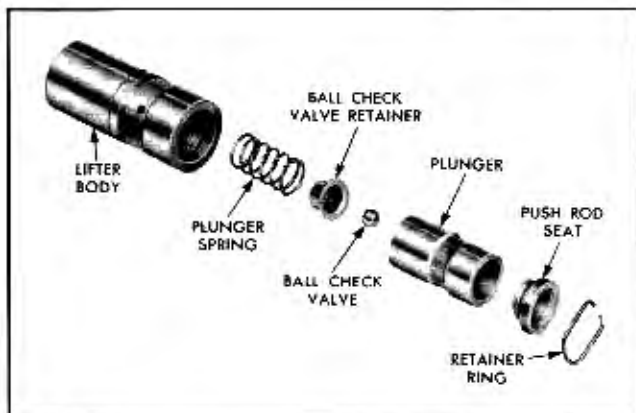

Fig. 6-51 Exploded View of Valve Lifter

5. Wipe out tank cover and place tray of parts on cover in front of tank (Fig. 6-50). A shop towel under tray and clean paper on remainder of cover will enhance cleanliness.

6. Working on one lifter at a time and using *clean, lint-free* cloths, thoroughly wipe off lifter parts. Clean plunger and external and internal surfaces of body with a hard wiping action. A bristle brush may be used to clean internal surface of lifter body. **CAUTION:** Do not use wire brush or sand paper, since damage to machined surface is likely. **NOTE:** Absolute cleanliness can be assured if each lifter is inspected and assembled after cleaning, but before proceeding to the next lifter.

7. Inspect lifter body. Both inner and outer surfaces of lifter body should be inspected for scoring. Lifter assembly should be replaced if body is roughly scored, grooved, or galled. Inspect cam contact surface on lower end of lifter body. Replace the lifter assembly if this surface is excessively worn, galled or otherwise damaged.

8. Inspect lifter plunger. Using a magnifying glass, inspect the check ball seat for defects. Inspect outer surface of plunger for scratches or scores. Small score marks with a rough, satiny finish will cause the plunger to seize when hot but operate normally when cool. Defects in check ball seat or scores or scratches on outer surface of plunger which may be felt with a fingernail are causes for replacing the lifter assembly. This rule does not apply to the slight edge which may sometimes be present where the lower end of plunger extends below the ground inner surface of the body. This edge is not detrimental unless it is sharp or burred.

A blackened appearance is not a defective condition. Sometimes the discoloration serves to highlight slight grinder chatter marks and give the outer surface of plunger a ridged or fluted appearance. This condition will not cause improper operation, therefore, it may be disregarded.

9. Inspect push rod seat. Inspect push rod seat for roughness and to insure that hole in center is open.

10. Inspect valve lifter ball. Carefully examine ball for nicks, imbedded material or other defects which would prevent proper seating. Such defects may cause intermittently noisy lifter operation.

VALVE LIFTER—ASSEMBLE

NOTE: All parts must be absolutely clean when assembling a hydraulic lifter. Since lint and dust may adhere to parts they should not be blown off with air or wiped with cloths. All parts should be rinsed in clean kerosene and assembled without drying. A small container with clean kerosene (separate from cleaning tank) should be used for each set of lifters being overhauled.

Figure 6-51 shows the relative position of component parts of valve lifters. The recommended procedure for assembly is given in the following steps.

1. Rinse plunger spring and ball retainer and position retainer in spring.
2. Rinse lifter ball and place in retainer.
3. Rinse plunger and place on retainer so that seat on plunger mates with ball.
4. Invert plunger with parts assembled thus far and, after rinsing lifter body, install body over spring and plunger.
5. Place lifter body on clean paper; rinse and install push rod seat and retainer ring.
6. After lifter has been assembled, place in lifter box and close lid to preserve cleanliness.

VALVE LIFTER LEAKDOWN RATE—TEST

After all lifters have been assembled, the leakdown rate must be checked before they are installed in the engine. Valve Lifter Leakdown Tester J-5790 (Fig. 6-52) is designed to test leakdown rate of lifters to determine whether or not they are within specified limits. As with previous service operations concerned with lifters, cleanliness is paramount. The tester cup, ram



Fig. 6-52 Testing Leakdown Rate

and ball should be thoroughly cleaned, and testing should be done in an area free of dust and dirt. The testing procedure is described in the following steps.

1. Fill tester cup to approximately one inch from top with special fluid which is available from Kent-Moore Organization. NOTE: No other type fluid is recommended.
2. Swing weight arm up out of the way, raise ram, and position lifter into boss in center of tester cup.
3. Place $\frac{7}{32}$ " steel ball in push rod seat of lifter and lower ram onto ball.
4. Adjust ram (with weight arm clear of ram) so that the pointer is positioned on the set line (marked "S"). Tighten jam nut to maintain setting.
5. Operate lifter through full travel of plunger by pumping weight arm to fill lifter with test fluid and force out air. (Lifter must be completely submerged at all times.) Continue pumping for several strokes after definite resistance is detected. NOTE: If noticeably weak resistance is detected during any one of last few strokes (of hard pumping), replace ball in lifter and repeat test to this point.
6. Raise weight arm to allow plunger spring to expand fully; lower arm onto ram and commence

turning crank slowly (1 revolution every 2 seconds). Time indicator travel from lower line (first line above set line) to line marked .125 or $\frac{1}{8}$ ", while still rotating cup with crank (Fig. 6-52). Lifter is satisfactory if rate is between 12 and 40 seconds.

A doubtful lifter should be tested three or four times. Disassemble, inspect, and re-test doubtful lifters. If leakdown still is not within specifications, replace lifter.

7. After each lifter is tested, replace in lifter box to insure cleanliness. Leave lifters in box until ready for installation in cylinder block.

8. When all lifters have been tested, empty cup, clean, and place cover over tester to maintain its cleanliness.

CYLINDER BLOCK, CRANKSHAFT, CAMSHAFT AND RELATED PARTS— CLEAN AND INSPECT

CYLINDER BLOCK—CLEAN AND INSPECT

1. Visually inspect all water and oil passage plugs for evidence of leakage and thoroughly clean exterior of block.
2. With block inverted clean out water jacket, using steam or suitable pressure type cleaning equipment, by injecting solution through two large holes in front of block.
3. Remove all oil passage plugs (Figs. 6-53 and 6-54).
4. Flush out all oil passages in the block (refer to "Oil Circulation", page 6A-4) with suitable pressure type cleaning equipment using tri-sodium phosphate and hot water, steam, or equivalent cleaning solvent. NOTE: The oil passages (Fig. 6-54) in the block which supply oil from the front center and rear center camshaft bearings to the right and left cylinder heads respectively are considerably larger than the oil holes in the camshaft bearings (Fig. 6-55). Due to this fact, sludge may collect in the passages above these bearings and may subsequently be forced into the oil galleries of the cylinder head, causing possible restriction of the oil passages in the rocker arm studs. For this reason these passages should be thoroughly cleaned and inspected.
5. Immediately after cylinder bores, valve lifter bores and other machined surfaces have dried, apply oil to prevent rusting.

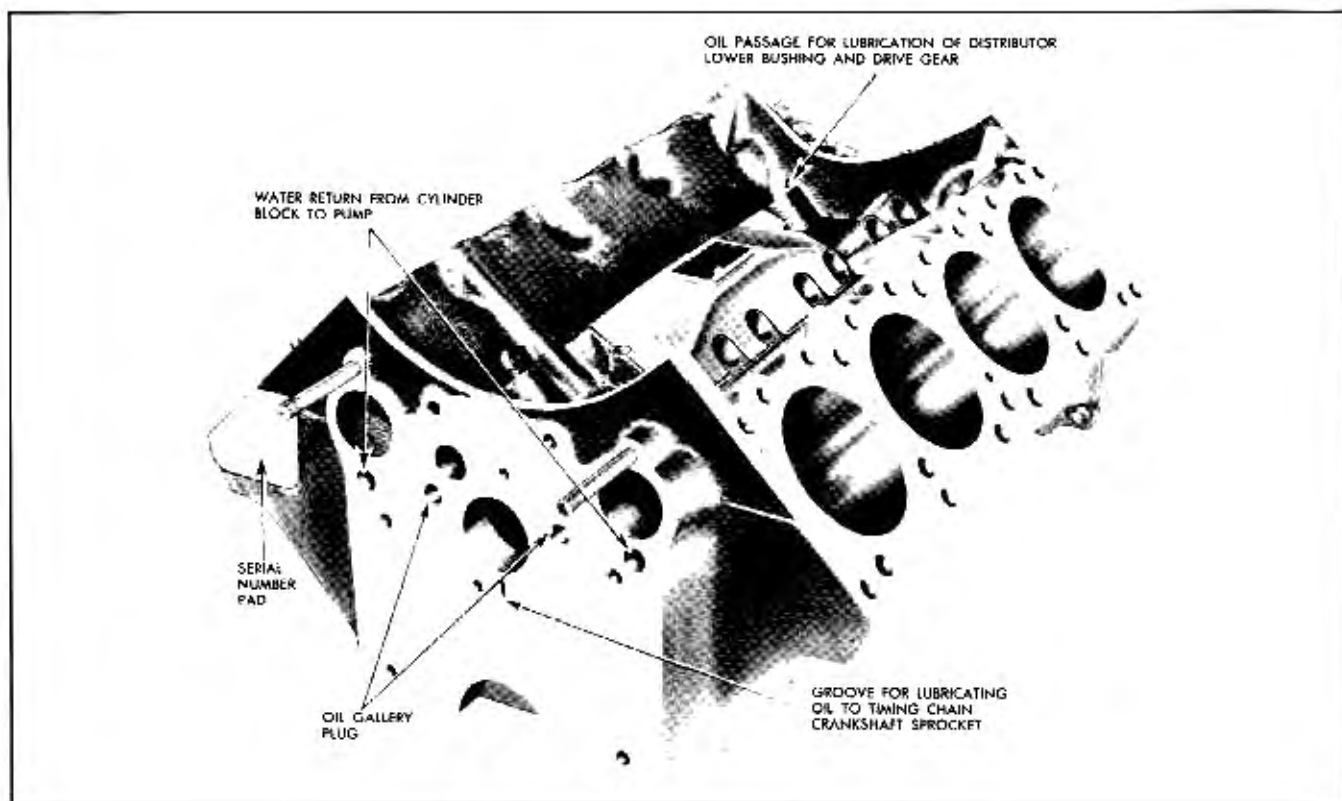

Fig. 6-53 Cylinder Block—Viewed from Left Front

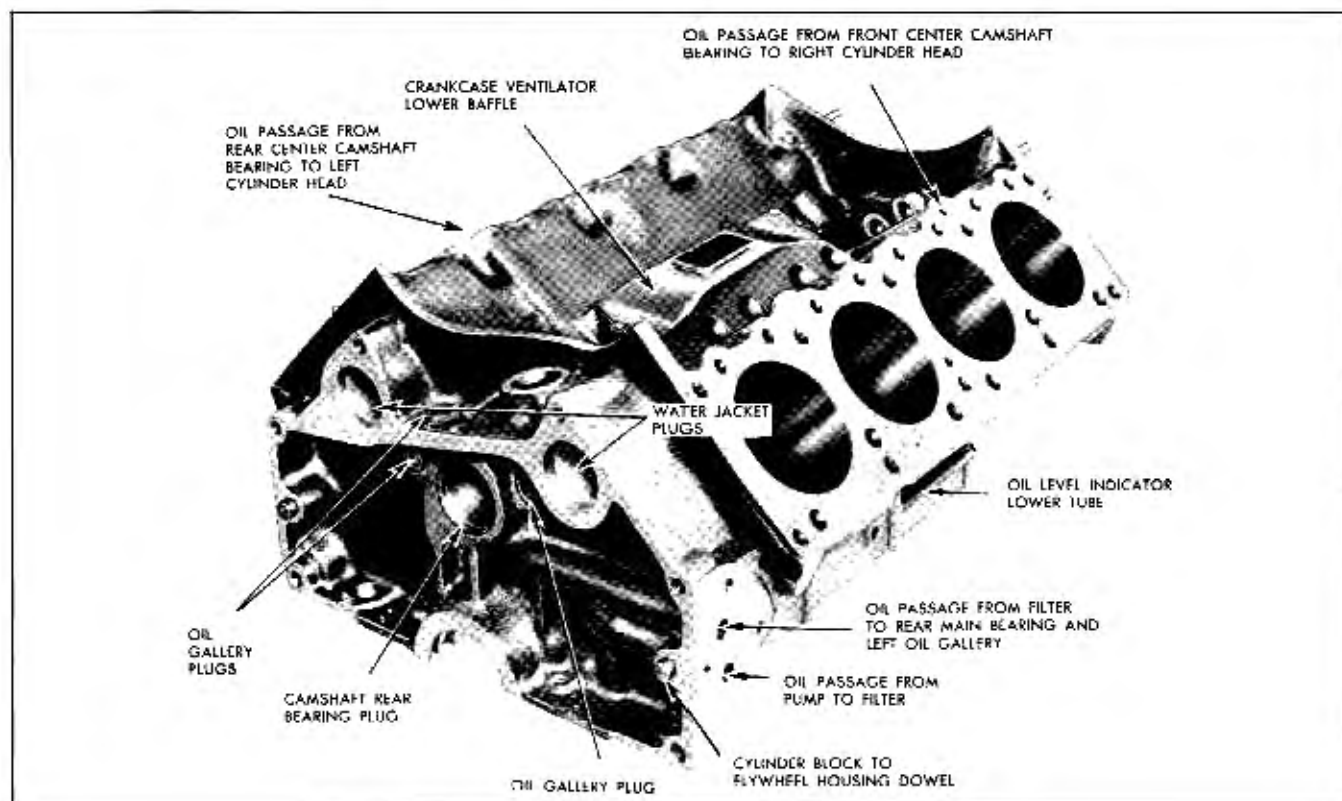

Fig. 6-54 Cylinder Block—Viewed from Right Rear

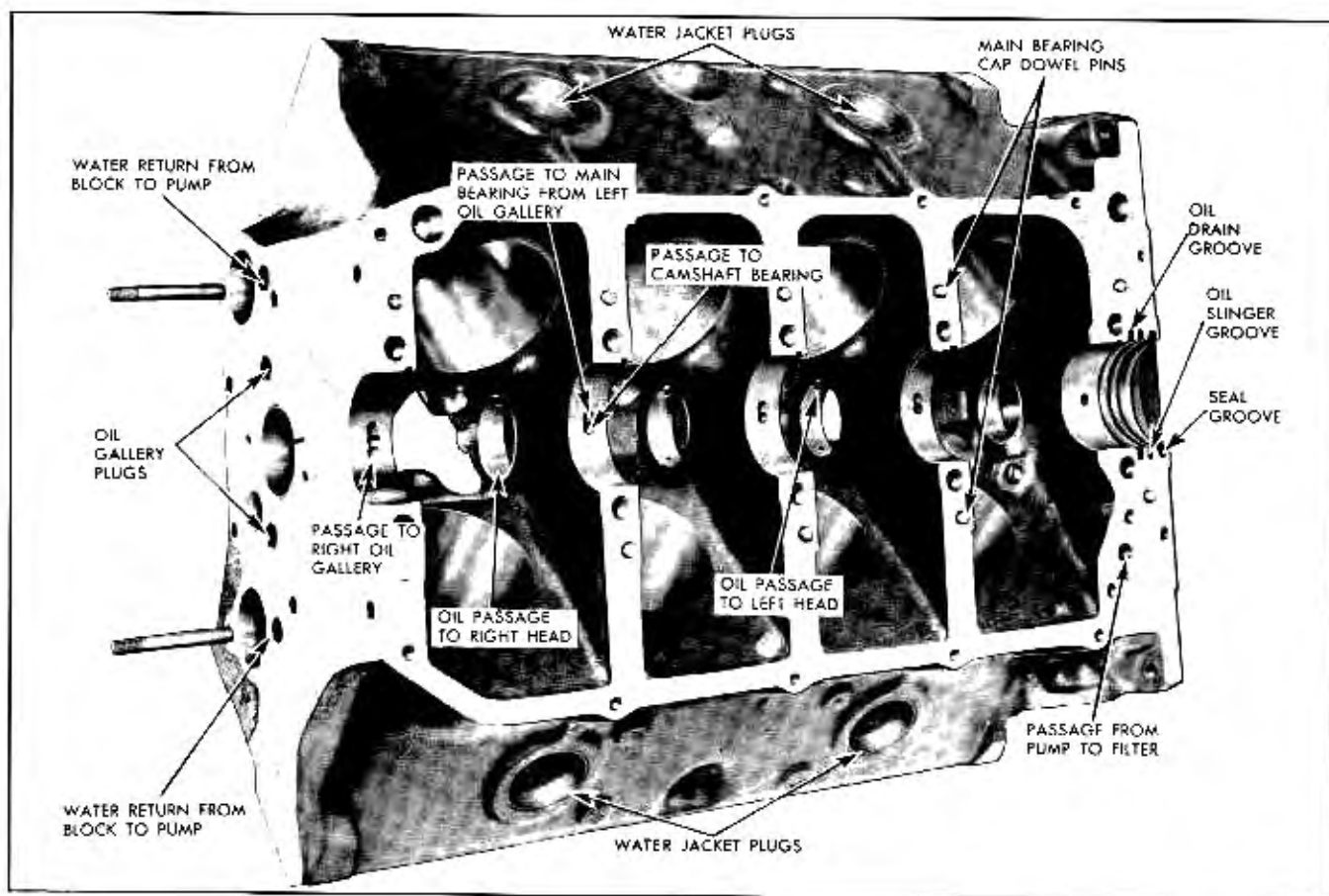

Fig. 6-55 Cylinder Block—Viewed from Bottom

6. Examine block thoroughly for evidence of cracks. Check all machined surfaces for burrs, scores, and scratches.

7. Visually inspect condition of cylinder bores and check for out-of-round and taper using suitable measuring equipment.

8. Visually inspect camshaft bearings for scoring, galling, or evidence of excessive wear. See page 6-12 for camshaft bearing replacement.

9. Check fit of each valve lifter in its boss. Lifters should have .0013" to .0028" in boss of block. If clearance is excessive, lifter should be replaced with an oversize lifter. Lifters are serviced .001" and .002" oversize. Reaming of lifter bosses is not recommended.

10. Inspect all oil passages in block to see that they are not obstructed. The following is a suggested procedure.

a. With cylinder block inverted, use pen light to see that passage from oil pump to filter is open (Fig. 6-55).

b. Check passage from filter outlet to rear main bearing by inserting wire in oil filter outlet passage and using pen light to see that wire is visible in passage to rear main bearing (Fig. 6-54).

c. Visually check passage from each main bearing to corresponding camshaft bearing (Fig. 6-55).

d. Check passage from filter outlet (through left oil gallery) to main bearings. Use rubber hose to blow smoke in oil filter outlet while observing to see that smoke passes out passages leading to all main bearings.

e. With cylinder block right side up, check oil passages to left bank lifter bosses. Use rubber hose to blow smoke in oil filter outlet while observing for smoke passing out oil passages from left main oil gallery to lifter bosses.

f. Check oil passages to right bank lifter bosses. Use rubber hose to blow smoke in passage from front main bearing to right main oil gallery while observing for smoke passing out passages from right gallery to lifter bosses.

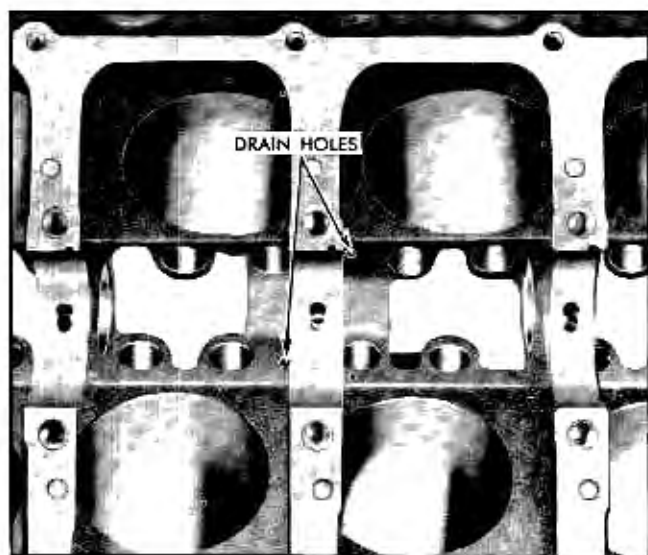

Fig. 6-56 Drain Holes Under Lower Crankcase Ventilator Baffle

g. Visually check passage from rear center camshaft bearing to left cylinder head and passage from front center camshaft bearing to right cylinder head (Figs. 6-53 and 6-54).

h. Use wire to check two drain holes under lower crankcase ventilator baffle (Fig. 6-56).

CRANKSHAFT AND MAIN BEARINGS—CLEAN AND INSPECT

1. Inspect main bearing journals and crankpins for scoring or galling. Measure crankpins and bearing journals to see that maximum out-of-round and taper does not exceed .0005".

2. Inspect main bearing shells to be sure that they are serviceable. Fit of bearings should be checked when engine is being assembled.

CAMSHAFT, THRUST PLATE, AND FUEL PUMP ECCENTRIC—CLEAN AND INSPECT

1. Check camshaft for general condition. Bearing journals should not be scored or burred. Cam lobes should be smooth and free of burrs and grooves. Oil pump drive gear should not have excessive wear.

2. Inspect camshaft thrust plate to see that no groove or ridge has been worn into bearing side of plate.

3. Inspect fuel pump eccentric for evidence of excessive wear. (See step 19, page 6-17).

TIMING CHAIN AND SPROCKETS—CLEAN AND INSPECT

Clean sprockets and chain and inspect for evidence of excessive wear.

CONNECTING ROD AND PISTON SERVICE

NOTE: Use care at all times when handling and servicing connecting rods and pistons. To prevent possible damage to these units, do not clamp rod or piston in vise since they may become distorted. Do not allow pistons to strike against one another, against hard objects, or bench surfaces, since distortion of piston contour or nicks in the soft aluminum material may result.

CONNECTING ROD AND PISTON—DISASSEMBLE

1. Remove piston rings using suitable piston ring remover. **NOTE:** It is important that rings be removed carefully to prevent scratching or burring of ring grooves and lands.

2. Remove snap rings which retain pin in piston. **NOTE:** Production snap rings have one prong, service rings have two prongs (Fig. 6-57). Production engines may be equipped with either one prong or two prong snap rings. It may be necessary to use a brass drift to tap pin out of piston pin bosses. **NOTE:** When using brass drift, use care to prevent damage to piston bosses. The possibility of damage can be reduced by grinding a shoulder on the drift which will project inside the piston pin. This will prevent end of drift from contacting piston pin boss.

3. Remove bearing cap and bearings, and rod bolts.

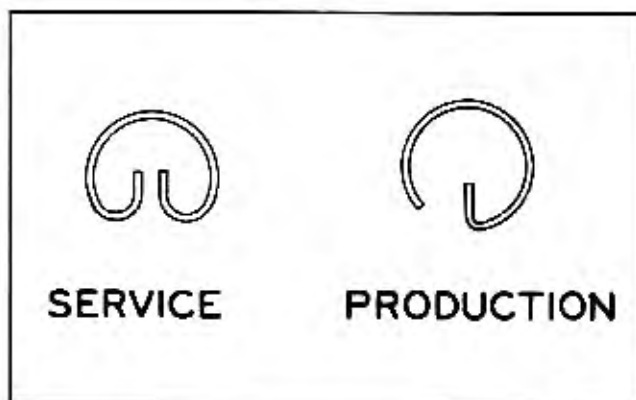

Fig. 6-57 Service and Production Type Snap Rings

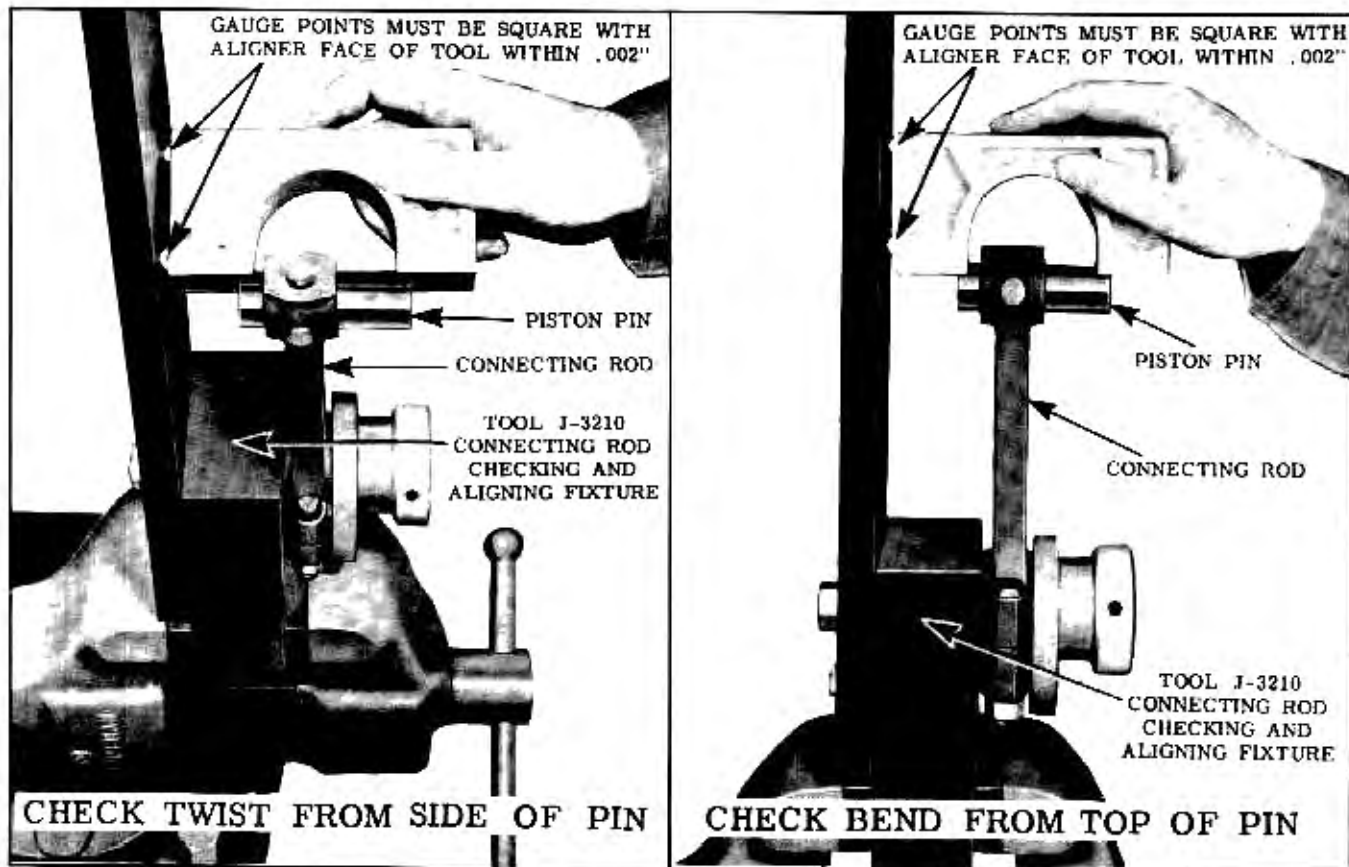

Fig. 6-58 Checking Connecting Rod Alignment

CONNECTING ROD AND PISTON—CLEAN AND INSPECT

1. Clean carbon, varnish, and gum from piston surfaces, including underside of piston head. Clean ring grooves, and oil holes in oil ring groove and piston pin bosses, using suitable cleaning tools and solvent.

2. Clean connecting rod. Insure that oil hole from top of rod to pin bushing is open.

3. Clean piston pin, rod cap, bolts and nuts in suitable solvent. Reinstall cap on connecting rod to assure against subsequent mixing of caps and connecting rods.

4. Carefully examine piston for rough or scored bearing surfaces; cracks in skirt or head; cracked, broken, or worn ring lands; and scored or galled piston bosses. Damaged or faulty pistons should be replaced. **NOTE:** If piston pin bosses are rough or worn out-of-round and the piston is otherwise serviceable, the pin bosses may be honed for oversize pins (page 6-40). Before fitting oversize pins, how-

ever, it is advisable to check fit of piston in bore (page 6-37).

5. Inspect piston pin for scoring, roughness, or uneven wear and test fit of pin in connecting rod bushing and piston (page 6-40).

6. Inspect bearing shells to see that they are serviceable. Fit of bearings should be checked when engine is being assembled.

7. Check alignment of connecting rod with Connecting Rod Checking and Alignment Fixture J-3210 (Fig. 6-58). The two points on the gauge must be square with aligner face within $.002''$ at both top and side of pin. (Gauge check at top tests for bend in rod, whereas check at side tests for twist.) If rod is not in proper alignment, it must be replaced. **CAUTION:** Do not attempt to straighten a bent or twisted rod.

PISTON FITTING AND REPLACEMENT

Pistons should be fitted in the bores by actually measuring the fit. Clearance between the piston skirt and the cylinder bore should be $.0007''$ to $.0017''$.

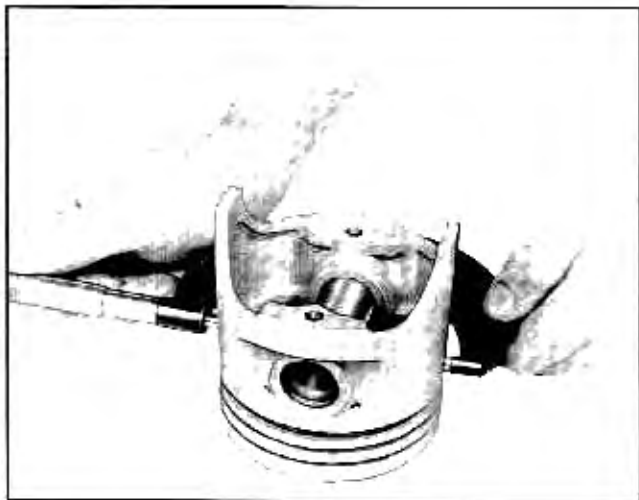

Fig. 6-59 Measuring Piston

If cylinder bores have been reconditioned, or if pistons are being replaced, reconditioning of bores and fitting of pistons should be closely coordinated. If bore has been honed, it should be washed thoroughly with hot, soapy water and stiff bristle brush.

Using a cylinder checking gauge, measure the cylinder bore crosswise of the block to find the smallest diameter. Record the smallest diameter of each bore. **NOTE:** When measuring cylinder bores and pistons it is very important that the block and pistons be at room temperature. If any or all of the parts are hotter or colder than normal room temperature, improper fitting will result.

Measure the piston skirt perpendicular to the piston pin boss (piston pin removed) and just far enough below the top of the skirt to make sure the micrometer is in full contact (Fig. 6-59).

As the pistons are measured they should be marked for size identification and the measurements recorded. If there is excessive clearance between a cylinder bore and the piston which was installed in that bore, a new piston should be used.

New pistons are serviced for both standard and premium fuel engines in standard size and .005", .010", .020" and .030" oversizes. **NOTE:** Since these are nominal or basic sizes, it is important that new pistons be measured to ensure proper fit. All new pistons are serviced with selectively fitted piston pins; therefore, it is important to check the fit of piston pin in connecting rod bushings.

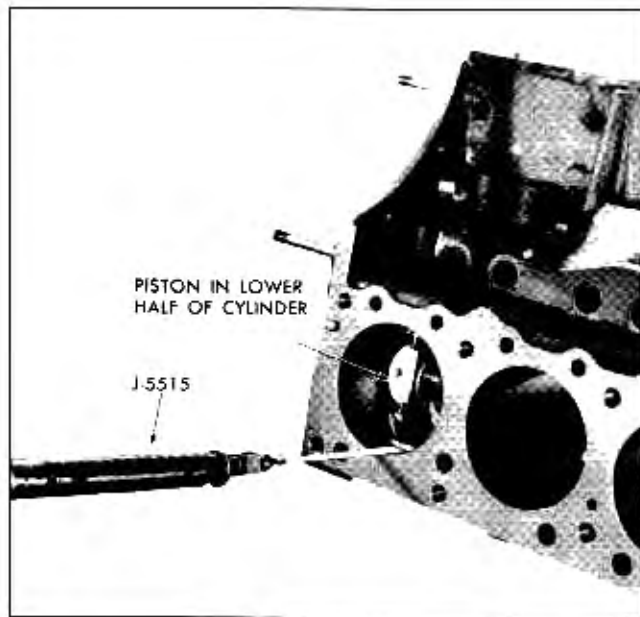

Fig. 6-60 Checking Fit of Piston in Bore

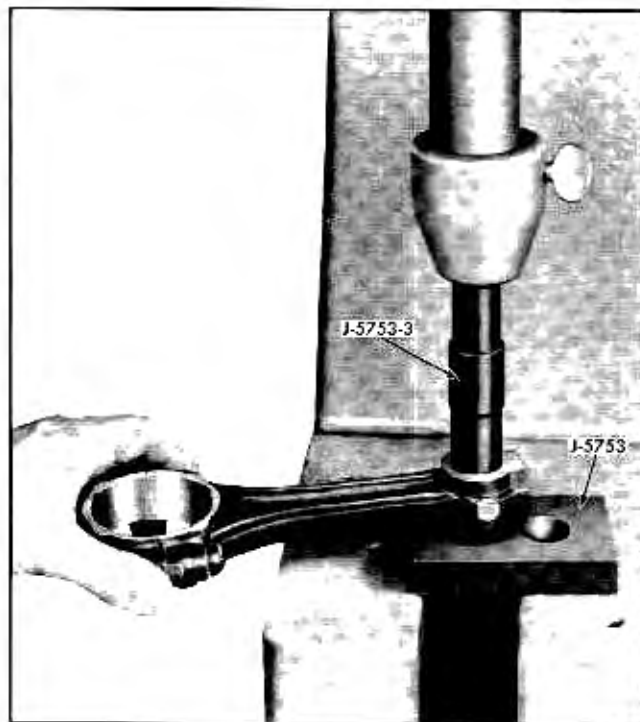

Fig. 6-61 Removing Connecting Rod Bushing

After all measurements have been made, match the new pistons with the cylinders where they will fit with a clearance of .0007" to .0017". (Honing of cylinder bore may be necessary to effect a proper fit.) When properly mated, mark the pistons with the cylinder numbers they fit so they will not become mixed.

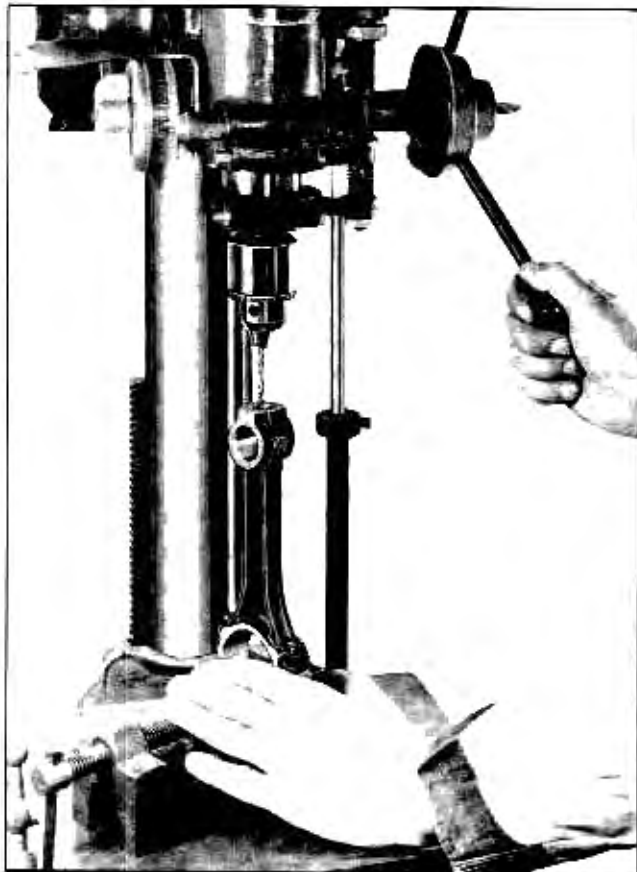

Fig. 6-62 Drilling Oil Hole in Connecting Rod Bushing



Fig. 6-63 Burnishing Connecting Rod Bushing

If the equipment required to measure fit of pistons in cylinder is not available, a fit can be satisfactorily checked using a $\frac{1}{2}$ "x.0015" feeler ribbon and spring scale such as J-5515. When fitting pistons to cylinders by this method, the fit should be checked with the piston in the lower half of the cylinder, and both cylinder wall and piston clean and dry. The $\frac{1}{2}$ "x-.0015" feeler ribbon should require a pull of 8 to 15 lbs. when drawn from between the piston (without rings) and cylinder wall (Fig. 6-60).

CONNECTING ROD BUSHING—REMOVE AND REPLACE

1. Press out old bushing using Bushing Remover and Installer J-5753-3 and Block J-5753 (Fig. 6-61). **NOTE:** For removal of bushing, the smallest diameter (third shoulder) on tool is inserted in bushing.

2. Press new bushing into place using same tools as in the above step, but using the opposite end of Bushing Remover and Installer J-5753-3. This tool must be used since the thin wall bushing will distort when pressed into rod unless supported by shank of tool.

3. Drill $\frac{5}{32}$ " hole in bushing (Fig. 6-62). **NOTE:** Use care to prevent end of drill from damaging opposite side of bushing.

4. Swage or expand bushing into connecting rod using Burnisher Tool J-5753-1 and Block J-5753 (Fig. 6-63). **NOTE:** This operation is essential. If it is not done, bushing may rotate or move out of rod, thereby restricting lubrication hole.

5. Hone bushing to fit piston pin with which it is to be used (page 6-40). It is advisable to use new piston pin when new bushing is installed if there is any measurable wear on the old pin. A Sunnen hone (Fig. 6-64) or similar accurate equipment should be used to perform the honing operation on the bushing since the hole must be perfectly round with no taper, and clearance between bushing and pin should be from .0001" to .0006". Hand operated expansion reamers or small hones used in electric drills are not satisfactory for sizing piston pin bushings.

6. Check alignment of rod (step 7, "Cleaning and Inspection", (page 6-37). If alignment is beyond specifications, install new rod. Do not attempt to correct alignment by bending rod.

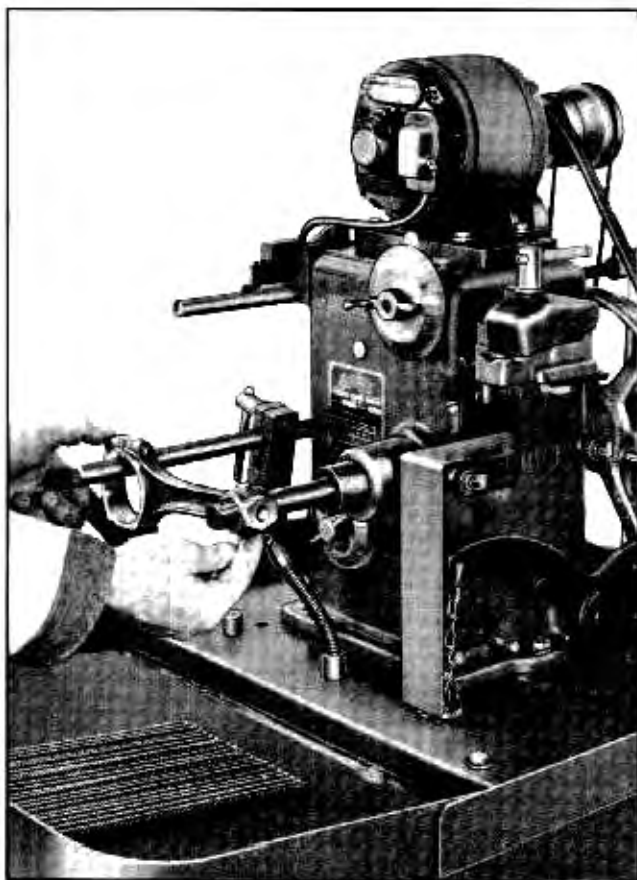

Fig. 6-64 Honing Connecting Rod Bushing

PISTON PIN FITTING AND REPLACEMENT

The fit of piston pin should be checked in the piston and also in the bushing. When new pistons (with pins), oversize pins, or new rod bushings are installed, honing of bushing or piston pin bosses, or both, may be necessary to effect a proper fit.

FITTING PIN IN ROD

The fit of piston pin in rod bushing should be .0001" to .0006" loose. Pin and bushing should be dry when checking this fit. If clearance is excessive, new bushing or oversize pin should be installed. Hone bushing to size (Fig. 6-64).

FITTING PIN IN PISTON

The piston pin fit in piston is .0000" to .0004" loose with pin and bosses clean and dry. When clearance is toward mean limit (.0002"), pin can be inserted with light hand pressure. When clearance is toward low limit (.0000"), considerable hand pressure will be required. (By using a brass drift, pin can be tapped into

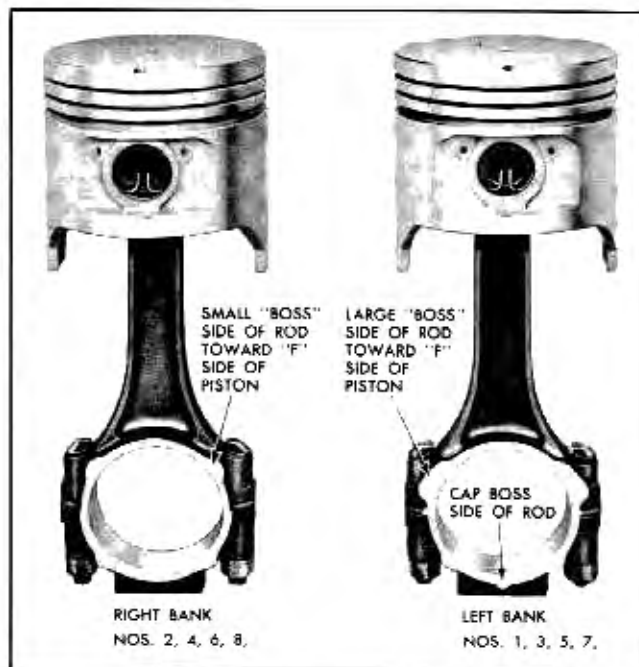

Fig. 6-65 Correct Assembly of Rod to Piston

place with light pressure.) CAUTION: Piston and pin must be at room temperature when checking fit.

FITTING OVERSIZE PINS

In case the standard size piston pin does not fit properly in the piston, an oversize piston pin must be fitted. Piston pins are available in .001" and .003" oversize.

When oversize pins are used, the piston pin holes must be honed to give the required fit. It will also be necessary to hone the connecting rod bushing to fit the oversize pin using a Sunnen hone or similar accurate equipment.

ASSEMBLY OF CONNECTING ROD TO PISTON

All pistons have an "F" cast on the front side. There is also a notch cast in the top of the piston head at the front to facilitate proper installation. The piston assemblies should always be installed with the notch toward the front of the engine.

The odd numbered piston assemblies will always be installed in the left hand bank of cylinders, while the even numbered piston assemblies will always be installed in the right hand bank of cylinders.

One side of the connecting rod will have large machined bosses with cap boss (Fig. 6-65). This side of the connecting rod and cap of the two adjacent rods

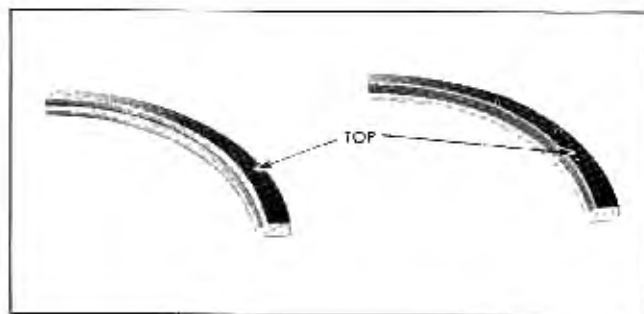

Fig. 6-66 Optional Compression Ring Construction

on each crankpin will always be facing each other.

This means that the large machined bosses on odd numbered rods will always be facing the front of the engine, while the small machined bosses on even numbered rods will also be facing the front of the engine. When the rod and piston are correctly installed, the oil groove between the rod and cap will be on the left side on even numbered rods, and on the right side on odd numbered rods.

After rod is assembled to piston, install new snap rings in piston pin bosses. Make sure they are fully seated in snap ring groove.

INSTALLATION OF PISTON RINGS

Two compression rings and one oil control ring, all above the piston pin, are used on pistons for both standard and premium fuel engines. The compression rings are taper faced and also have either a step or a chamfer on the inside diameter of the top side (Fig. 6-66). The top compression ring is chrome plated while the lower compression ring is lubrited.

New rings are serviced for the standard size pistons, and for .005", .010", .020", and .030" oversize pistons. When selecting rings be sure they match the size of the piston on which they are to be installed, i.e. standard rings for standard pistons, .010" oversize rings for .010" oversize pistons, etc. Ring gap and side clearance should be checked while installing rings as follows:

1. Check pistons to see that ring grooves and oil return holes have been properly cleaned.
2. Place ring down at the bottom of the ring traveled part of the cylinder bore in which it will be used. Square ring in bore by pushing it into position with head of piston.
3. Measure gap between ends of ring with feeler

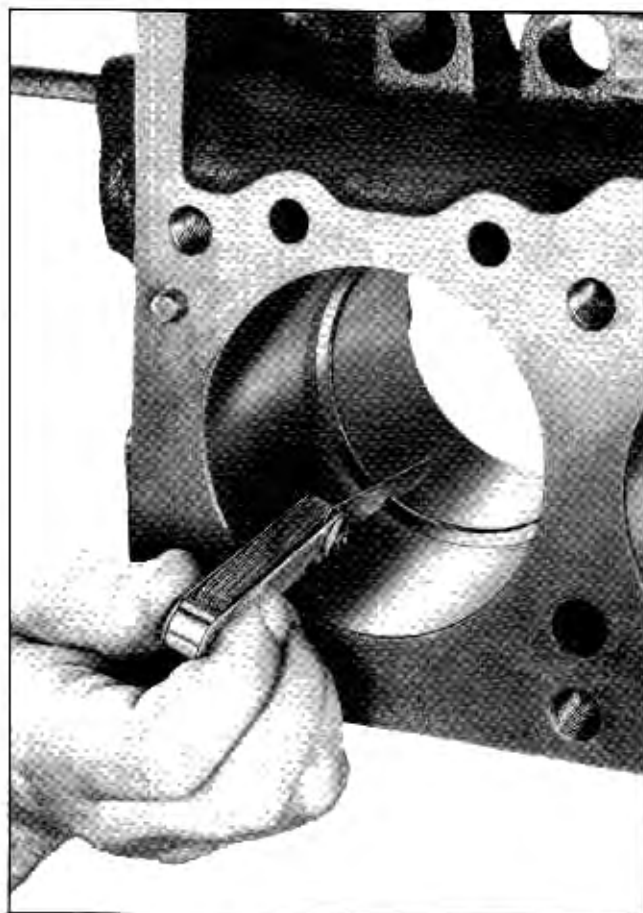

Fig. 6-67 Checking Ring Gap

gauge (Fig. 6-67). Gaps should be as follows:

Upper Compression Ring	.010"-.020"
Lower Compression Ring	.008"-.020"
Oil Ring	.015"-.055"

Incorrect ring gap indicates that wrong size rings are being used. If rings are selected according to the size of the bore (standard, .005" oversize, etc.) they should have the proper gap. It should not be necessary to alter ring gap by filing.

4. Install rings on piston using good ring installing tool to prevent breakage, or fracture of rings, or damage to pistons.

5. Measure side clearance of rings in ring groove (Fig. 6-68) as each ring is installed. Clearance with new pistons and rings should be as follows:

Upper Compression Ring	.0015"-.0030"
Lower Compression Ring	.0015"-.0035"
Oil Control Ring	.0006"-.0084"

If side clearance is excessive, piston should be replaced.

CAMSHAFT BEARING REPLACEMENT

Camshaft bearings can be replaced while the engine is disassembled for overhaul, or without completely disassembling the engine. To replace bearings without completely disassembling engine, remove the camshaft and crankshaft, leaving cylinder heads attached and pistons in place. Before removing crankshaft, tape threads of connecting rod bolts to prevent damage to crankshaft. Fasten connecting rods against sides of engine so they will not be in the way when replacing bearing.

BEARING REMOVAL

1. Insert Replacer Adapter J-6173-3 into front bearing to act as a support for Shaft J-6173-1. **NOTE:** If front bearing is to be replaced, insert Installer Adapter in center bearing to act as support for shaft.

2. Insert Remover Adapter J-6173-4 into rear of bearing to be removed so that shoulder on Remover bears against rear edge of bearing. **NOTE:** If rear bearing is to be removed, it will be necessary to remove camshaft rear plug.

3. Place Indexing Collar J-6173-6 on threaded end of shaft with open side toward unthreaded end and start thrust washer and nut on shaft.

4. Insert shaft and Indexing Collar through Remover and Replacer Adapters and position lug on Indexing Collar in ventilator hole in front of block (Fig. 6-69). This indexes the shaft so that it cannot rotate.

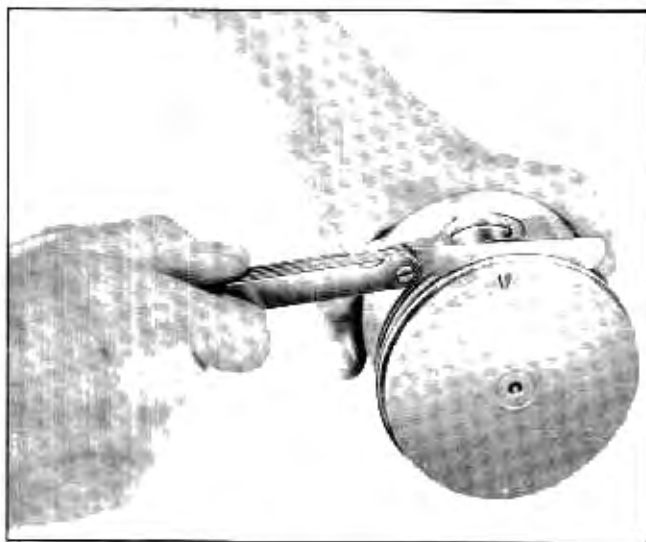

Fig. 6-68 Measuring Side Clearance of Ring in Groove

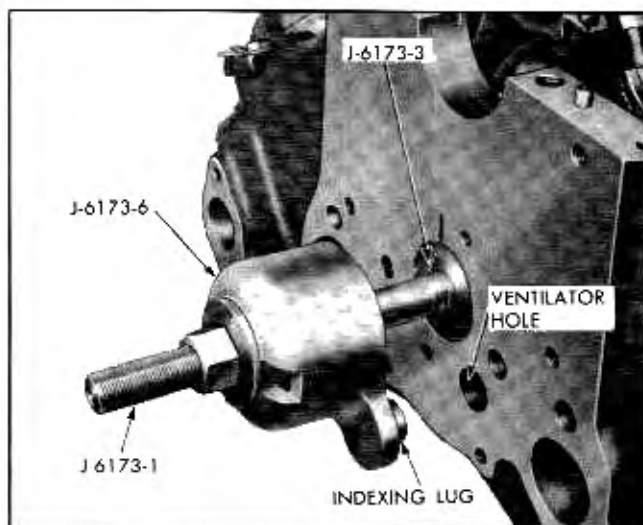

Fig. 6-69 Positioning Indexing Collar

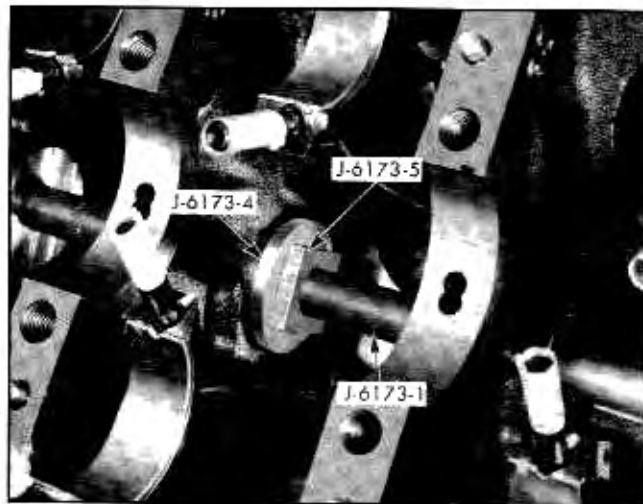

Fig. 6-70 Preparing to Remove Bearing

5. Slip Key J-6173-5 into notches in shaft behind bearing to be removed (Fig. 6-70).

6. Turn nut on front of shaft to pull key against Remover J-6173-4, then continue to turn nut until bearing is pulled out of its hole.

BEARING INSTALLATION

1. Place a rag against each side of the transverse member just below the bearing hole to catch any shavings and carefully clean up the hole. All scratches or nicks in the cast iron should be smoothed with a scraper or file, being careful not to get any chips in cylinder head gallery feed hole. Chamfer the rear edge of the hole slightly to reduce the possibility of shav-

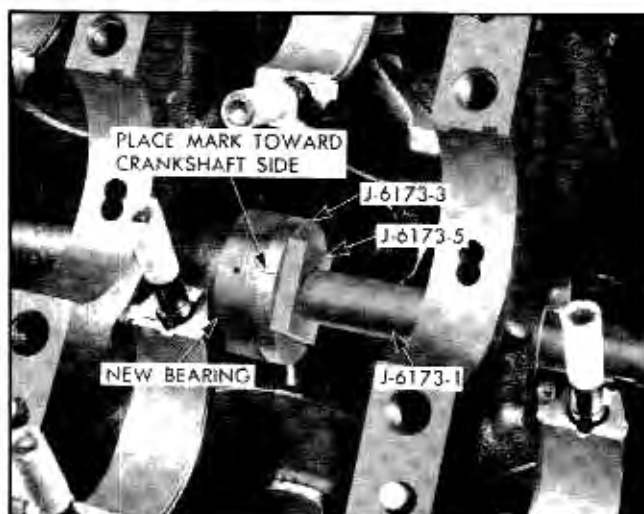

Fig. 6-71 Preparing to Install Bearing

ing down the outer diameter of the bearing when it is installed.

2. Insert Remover Adapter J-6173-4 into front bearing to act as a support for the shaft. **NOTE:** If front bearing is being replaced, insert Remover Adapter in center bearing to act as support for the shaft.

3. Insert pilot J-6173-7 into hole in which bushing is to be installed.

4. Coat outside of new bearing with oil and place it over Replacer Adapter J-6173-3, indexing notch in edge of bearing with pin on Replacer Adapter. **NOTE:** The notch in the edge of the bearing is used to properly position the bearing, with respect to the oil holes, when it is installed. When bearings are installed in production, the notches all face the front except the one in the rear bearing. In the field it is necessary to install bearings with the notch facing the rear.

5. Position Replacer Adapter J-6173-3, with bearing in position against shoulder, against rear of hole in which bearing is to be installed (Fig. 6-71). Index mark on shoulder of Replacer must point up (toward crankshaft side) to properly position bearing.

6. Insert Shaft with Indexing Collar, thrust washer, and nut through Remover, Pilot and Replacer Adapters and index lug on Collar with ventilation hole in front of block (Fig. 6-69).

7. Slip key J-6173-5 into notches in shaft behind Replacer Adapter J-6173-3 and tighten nut to start bearing into hole (Fig. 6-71). Continue to tighten nut

until bearing has been pulled completely into its hole. When properly positioned, it will be approximately flush with both sides of the transverse member. **NOTE:** Rear bearing should be pulled in until front edge is flush with block. This will leave shoulder at end of counterbore for camshaft rear plug visible behind bearing.

8. Remove Remover and Replacer Tool J-6173.

9. Visually observe that holes in bearing line up with drillings in block.

10. Carefully remove rags used to catch particles of metal and use magnet or vacuum cleaner to make sure that all metal particles are removed from block surfaces and oil drillings.

11. Coat inner diameters of all camshaft bearings with oil and install camshaft. Rotate camshaft through several revolutions to make sure it is completely free. If any tight spots are found, remove camshaft and very carefully polish down the center journal slightly. If still not free, polish the front and rear journals slightly. If any particular bearing causes binding of the camshaft, replace that bearing also. **NOTE:** Front center and rear center journals should not be polished except to remove slight roughness or scratches. Slight warpage of the camshaft is not harmful providing the journals are polished down until the camshaft rotates freely in its bearings.

ASSEMBLY OF ENGINE

1. Install drain cock in each side of block.

2. Install rear main bearing oil seal in block and cap as follows:

a. Place seal in groove in block and pack tightly with hammer and tool J-6528 (Fig. 6-72).

b. With tool still in place cut seal off flush with block. Remove tool from block.

c. Place seal in groove in bearing cap and pack tightly with hammer and tool J-6528.

d. With tool still in place carefully cut seal off flush with cap. Remove tool from cap.

3. Position main bearing shells in block.

The rear main bearing cap has three grooves, one for oil drain, one for the oil slinger and the other for the seal (Fig. 6-73). The bearing shells have two oil grooves. The front oil groove has an oil hole in the center while the rear oil groove has three oil drain holes evenly spaced. The upper and lower shells are

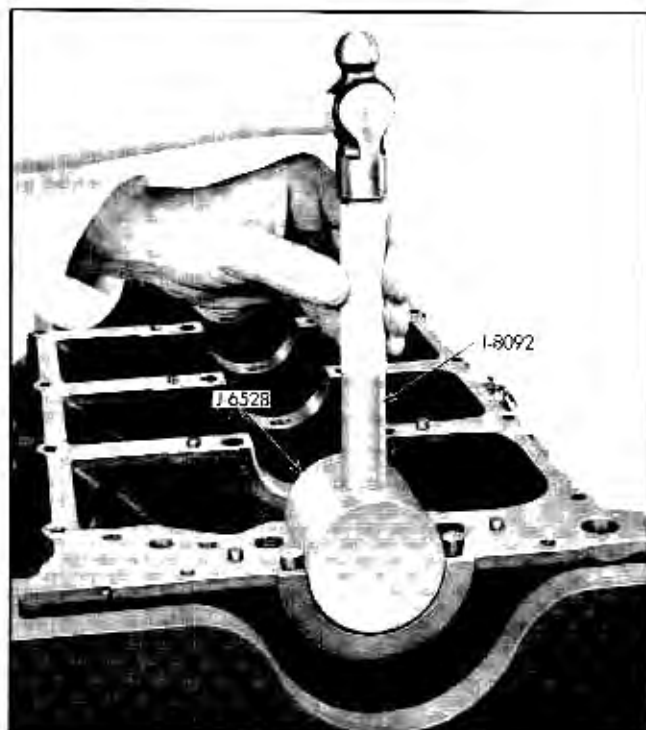

Fig. 6-72 Compressing Seal in Block

not interchangeable due to location of tang slots in block and cap. For the front, front center, center, and rear center bearings install the shells with the oil grooves in the cylinder block (upper) position and install the shells without the oil grooves in the cap (lower) position. There will be no oil supply to the bearings if the shells are reversed.

4. Carefully position crankshaft in place in bearings.

5. Position bearing shells in caps and install caps, measuring bearing clearances as follows: **CAUTION:** Under no circumstances should bearing caps be filed or shimmed in an effort to effect a fit.

PLASTIGAGE METHOD

a. Place a piece of Plastigage plastic (Group 0.093 Master Parts Catalog) the length of bearing in bearing (bearing must be free of oil); install bearing and cap and tighten to specified tightness given in step 6 below. **DO NOT TURN CRANKSHAFT WITH PLASTIGAGE IN PLACE.**

When position of engine is such that weight of crankshaft is on bearing caps, all bearing caps must be in place and tightened so crankshaft weight will be properly supported and not give error in reading at bearing being checked.

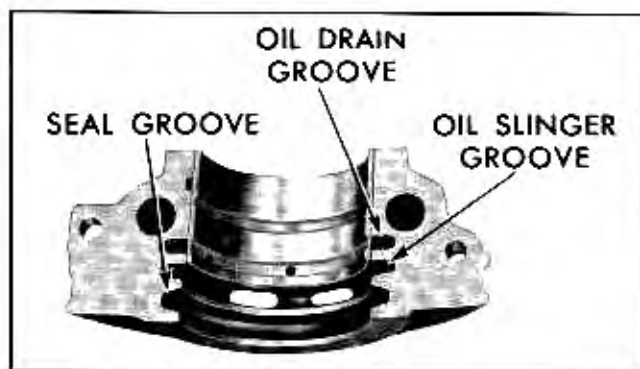

Fig. 6-73 Rear Main Bearing Cap and Shell

b. Remove bearing cap and using Plastigage scale measure width of flattened piece of plastic. If reading is not over $2\frac{1}{2}$, standard size main bearing should be used; if reading is over $2\frac{1}{2}$, use .001" undersize bearing and recheck. Main bearing inserts .002" undersize are available for cases where use of the .001" undersize bearing results in excessive clearance.

SHIM STOCK METHOD

a. Place .002" brass shim $\frac{1}{2}$ " wide by 1" long in main bearing cap with new standard bearing and install cap, pulling up bolts to specified tightness given in step 6 (page 6-45). Refer to (Fig. 6-74) for position of shim in cap.

b. Attempt to rock crankshaft by hand 1" in either direction. **CAUTION:** Do not attempt to move crankshaft more than 1" in either direction or shim may damage bearing.

c. Repeat test in step "b" without shim. If crankshaft moves freely without shim in place and locks with .002" shim, the standard bearing is satisfactory. If it is possible to rock the crankshaft freely with the

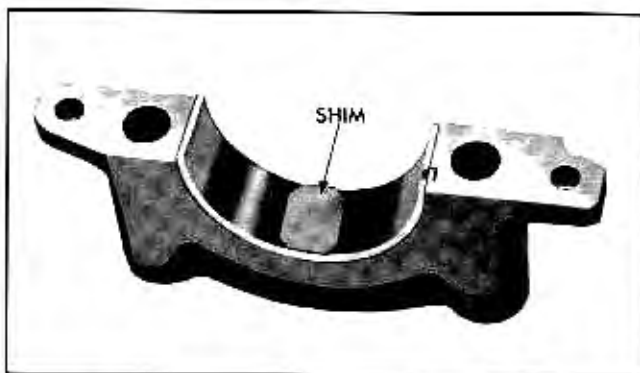

Fig. 6-74 .002" Shim Positioned in Cap for Checking Bearing Clearance

.002" shim, the .001" undersize bearing should be used and the fit rechecked. If necessary recheck with .002" undersize bearing.

6. After determining that the correct bearing insert has been fitted, tighten bearing cap to final tightness of 95 lb.-ft. torque except rear main bearing cap which should be tightened to 120 lb. ft. torque. **NOTE:** Before installing rear main bearing cap, apply a $\frac{1}{16}$ " wide bead of sealer on face of rear main bearing cap from packing groove to external cork groove on both sides. (Use crankshaft sealer Permatex No. 3.) Reinstall cap and tighten to 120 lb. ft. torque. **NOTE:** Lock washers are not used on main bearing cap screws.

7. Install camshaft being careful not to damage bearings as camshaft is inserted.

8. Position camshaft thrust plate over camshaft with groove facing block, install attaching screws with lockwashers, and tighten securely.

9. Make sure keys are in place in crankshaft and camshaft. Install timing chain and sprockets making sure marks in sprockets are aligned exactly on a straight line passing through the shaft centers (Fig. 6-27). Alignment can be simplified by first installing sprockets without chain to align timing marks. If timing chain is excessively loose, new chain or new chain and sprockets should be used.

10. Position fuel pump eccentric on camshaft sprocket (see step 19, page 6-17). Install attaching screw with retainer and tighten securely. Place hammer handle between block and crankshaft counterweight to hold shafts from turning.

11. Coat face of timing chain cover oil seal with graphite lubricant and install seal on end of crankshaft.

12. Turn engine right side up. Position timing chain cover gasket over studs and against block and install timing chain cover. Tighten attaching screws and nuts securely.

13. Slide harmonic balancer onto crankshaft, and install harmonic balancer to crankshaft bolt and washer. Place hammer handle between block and crankshaft counterweight to keep crankshaft from turning and tighten harmonic balancer to crankshaft bolt 160 lb. ft. torque.

14. Install connecting rod and piston assemblies in pairs as follows:

a. Turn crankshaft so crankpin for rod and piston

assemblies to be installed projects straight down. **NOTE:** Crankshaft can be turned by means of the harmonic balancer attaching screw.

b. Install Connecting Rod Bolt Guide Set on connecting rod bolts with long guide on side with oil groove (so it will be toward center of engine when installed).

c. Install bearing shell in connecting rod. **CAUTION:** When installing bearing shells, make sure they are squarely seated in the rod and cap. If care is not used with these relatively narrow bearings, they may be installed slightly askew (bearing not exactly parallel to rod or cap).

d. Using suitable ring compressor, insert connecting rod and piston assembly into bore with "F" on web of piston and notch on top of piston facing front. From beneath engine, use long guide to pull connecting rod into place against crankpin. Remove guide set from connecting rod bolts.

e. Position bearing shell in cap and install cap, measuring bearing clearance as follows: **CAUTION:** Under no circumstance should a bearing cap be filed or shimmed in an effort to effect a fit.

PLASTIGAGE METHOD

a. Place a piece of Plastigage plastic (see Group 0.093 Master Parts Catalog) the length of bearing in bearing (bearing must be free of oil); install bearing and cap and tighten nuts to 45 lb. ft. torque. **DO NOT TURN CRANKSHAFT WITH PLASTIGAGE IN PLACE.**

b. Remove bearing cap. Using Plastigage scale, measure width of flattened piece of plastic. If reading is not over $2\frac{1}{4}$, standard size connecting rod bearing should be used; if over $2\frac{1}{4}$, use .001" undersize bearing and recheck. Connecting rod bearing inserts .002" undersize are available for cases where use of the .001" undersize bearing results in excessive clearance.

SHIM STOCK METHOD

a. Place .0015" brass shim $\frac{1}{2}$ " wide by $\frac{7}{8}$ " long in bearing cap with new standard insert (Fig. 6-74) and install cap. Tighten nuts to 45 lb. ft. torque.

b. Attempt to move connecting rod endwise on crankpin by hand and then by a light tap of a hammer.

c. Repeat test to move rod endwise by hand with shim removed. If connecting rod did not move by

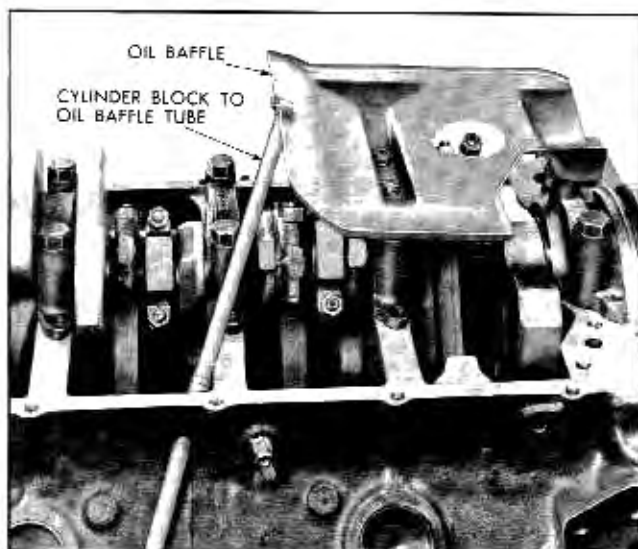

Fig. 6-75 Proper Assembly of Oil Baffle and Tube

hand, but moved by tap of hammer in Step "b" and moved freely in this step, the standard bearing should be used. If rod could be moved by hand in Step "b", install .001" undersize bearing. If necessary, recheck with .002" undersize bearing.

15. After determining that the correct bearing insert has been fitted, tighten connecting rod cap nuts to final tightness of 45 lb. ft. torque. Nuts are self-locking and require no lockwashers or cotter pins.

16. Position cylinder-block-to-oil-baffle tube and engine oil baffle on engine, install attaching screws with lockwashers and tighten securely (Fig. 6-75).

17. Install oil pump assembly, using gasket between pump and block. Use lock-washers on attaching screws and tighten securely.

18. Cement new gaskets to oil pan and rear main bearing cap, and install oil pan and all except the two rear screws. Position flywheel housing front shield against oil pan and flywheel housing. Install rear two oil pan screws and four shield to flywheel housing screws. Tighten oil pan screws to 12 lb. ft. torque.

19. Install each cylinder head as follows:

a. Position gasket on block, indexing with locating pins (gaskets are interchangeable end for end and side for side).

b. Position cylinder head on gasket, indexing with locating pins.

c. Install cylinder head screws and tighten evenly to 95 lb. ft. torque.

NOTE: Three different length screws are used. When inserted in the proper holes, all will project the same amount from their respective bosses. Do not use sealer of any kind on threads. Install screw with integral stud at left front corner of left head (for battery ground cable), and at right rear corner of right head (for radio ground strap).

20. Install lifters in bosses from which they were removed.

21. Install push rods and rocker arms with balls, and start rocker arm nuts. **NOTE:** Push rods should be installed in same places they were originally installed and with same end contacting rocker arm.

22. Tighten rocker arm ball retaining nuts to 15 lb. ft. torque.

23. Install distributor as follows:

a. Turn crankshaft to firing position of number one cylinder (number one exhaust and intake valve lifters both on the base circles of their cams (Fig. 6-76) and timing mark on harmonic balancer indexed with pointer).

b. Position new distributor to block gasket on block.

c. Install distributor (without cap and wires) so that vacuum diaphragm faces the left side of the engine and rotor arm points toward contact in cap for number one cylinder. It will also be necessary to turn the oil pump drive shaft so it will index with distributor shaft. Distributor and rotor will be positioned as shown in Fig. 12-58 when properly installed with number one piston in firing position.

24. Install distributor hold down clamp and special screw and tighten enough to hold distributor in place.

25. Cement new gaskets to push rod cover and crankcase ventilator lower baffle. Install push rod cover with two screws and flat washers and tighten to 10 lb. ft. torque.

26. Cement new gaskets to rocker arm covers and install covers leaving screws loose. (Some of the screws will have to be removed later to install wire and pipe clips.)

27. Position new intake manifold gaskets over studs on cylinder heads and install intake manifold. Install intake manifold screws and nuts using special flat washers under nuts. Tighten to 40 lb. ft. torque. **NOTE:** Attach heater hose bracket to intake manifold rear stud on left side. On Hydra-Matic models, install

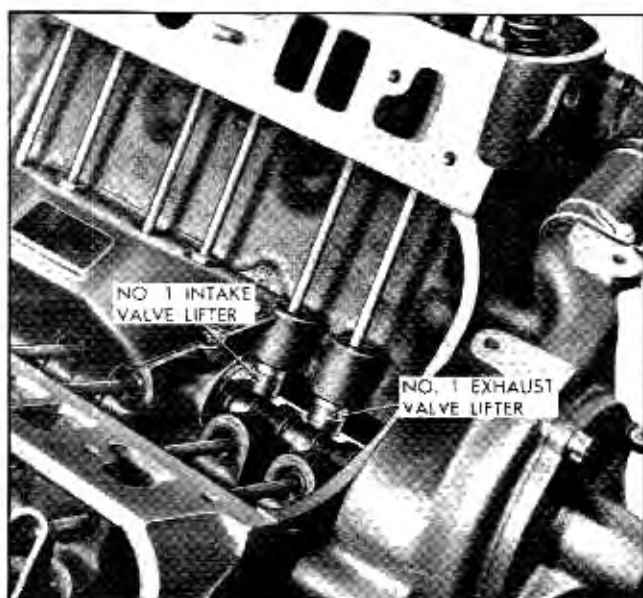

Fig. 6-76 Relationship of Lifters and Cams When Cylinder No. 1 is in Firing Position

throttle control engine bracket under left two rear screws.

28. Install cylinder head water inlet elbows and hoses on water pump outlets and cylinder heads. Use new gaskets under elbows and lockwashers on screws (leave upper screw of right elbow out until generator is installed).

29. Install both exhaust manifolds holding in place loosely with one screw at each end. Slide gaskets into place, install remaining screws and tighten to 25 lb. ft. torque. **NOTE:** Use new special locks under front and rear pairs of screws and bend tabs against screw heads after tightening.

30. Install exhaust crossover pipe using one thick (.135" thick) or two thin (.075" thick) gaskets at each flange. Install flange screws and tighten securely.

31. Position oil filter on block using new gasket, install attaching screws using flat washer and lockwasher and tighten securely.

32. Oil interior of crankcase ventilator outlet pipe seal and slide onto pipe. Insert pipe into flange on push rod cover, and slide seal down to cover connection. Slide outlet pipe to cylinder head clamp onto pipe and attach to rear of cylinder head.

33. Install fuel pump on pad on timing chain cover using new gasket (it may be helpful to turn crankshaft to put the fuel pump eccentric at the low point). Install screws with lockwashers and tighten securely.

34. Install carburetor using new asbestos gasket, and install choke heat suction tube.

35. Attach throttle control engine bracket to rear of cylinder head on Syncro-Mesh models. On cars equipped with Hydra-Matic transmission connect intermediate rod to carburetor throttle rod bracket, and connect cross shaft bracket to flywheel housing.

36. Attach carburetor throttle rod to throttle lever on carburetor.

37. Attach coil and bracket assembly to intake manifold using flat washer and lockwasher on each screw.

38. Install fuel and vacuum pipes between carburetor fuel filter, fuel pump and distributor. Attach pipe clips under rocker arm cover screws and tighten rocker arm cover screws to 3 lb. ft. torque.

39. Install spark plugs using new gaskets and tighten carefully to 25 lb. ft. torque.

40. Install distributor cap with spark plug and coil wires. Fasten spark plug wire supports to rocker arm covers and connect spark plug wires. Connect coil secondary wire and connect distributor to coil primary wire (connect to negative terminal of coil).

41. Install pulley and fan on water pump hub. Tighten self locking screws to 20 lb. ft. torque.

42. Install generator and mounting bracket assembly and adjusting strap. Tighten mounting bracket to intake manifold screws securely.

43. Install fan belt. Adjust fan belt tension by positioning generator where an eight lb. force applied midway between generator pulley and fan pulley will give $\frac{1}{4}$ " movement of fan belt. With generator in this position tighten all generator attaching bolts securely.

44. Install oil level indicator.

ENGINE INSTALLATION

1. Assemble clutch and transmission to engine.

2. Install front and rear insulators on engine.

3. Hook chain fall to intake manifold using a strong chain threaded through manifold immediately behind the carburetor.

4. Release engine from holding stand and very carefully lower into place in car. Fasten rear insulators to engine support rear cross member, and then fasten front insulator to front cross member. **NOTE:** On Hydra-Matic models it will be necessary to raise

the rear of the engine to install the engine support rear cross member. The rear of the engine should be raised by using a special automatic transmission jack under the transmission oil pan. *Do not use jack under engine oil pan.*

5. Install propeller shaft.
6. On Synchro-Mesh models, install clutch counter-shaft bracket on flywheel housing, connect clutch linkage, and adjust overcenter spring lever and pedal lash.
7. Connect gearshift manual linkage to transmission.
8. Connect exhaust pipe to right exhaust manifold connector using new gaskets. Use two thin (.075" thick) or one thick (.135" thick) gasket.
9. Connect solenoid wire loom to junction block on left fender skirt, routing loom beneath steering column and around cable guide on cover of power brake unit. Route battery cable in same manner and fasten in clamp on junction block.
10. Install crankcase ventilator outlet pipe and engine side aprons.
11. Install radiator and fan shroud.
12. Route right side wire loom through clips on radiator and connect to junction block on radiator support to fender brace.

13. Connect regulator to generator wires, routing through clips along right rocker arm cover. Connect coil primary lead and install thermogauge unit.

14. Connect power brake vacuum hose to check valve to carburetor pipe.

15. Connect flex fuel line to fuel pump, oil pressure gauge line to connector near dash, and windshield wiper vacuum pipe to hose.

16. Connect upper and lower radiator hose and heater lines. If Hydra-Matic transmission connect inlet and outlet oil lines to radiator.

17. Install power steering pump and belt and adjust belt tension.

18. Connect throttle linkage and install carburetor air cleaner.

19. Install battery cable and connect battery cables to battery posts. If new ground cable is installed be sure to connect it to bracket on battery support as well as to the engine.

20. Install hood.

21. Fill cooling system, crankcase, and transmission.

22. Adjust ignition timing, carburetor, and Hydra-Matic linkage.

SPECIFICATIONS

Type	90° V-8 O.H. Valve	
Bore and Stroke	3.94" x 3.56"	
Piston Displacement	347 cu. in.	
Taxable Horsepower	49.6	
Compression Ratio—H.M. Trans.	10.0:1	
Compression Ratio—S.M. Trans.	8.5:1	

HORSEPOWER AND TORQUE	S.M.	H.M.
Brake Horsepower—4 Barrel Carb.	244 @ 4800 RPM	270 @ 4800 RPM
Torque (lb. ft.)—4 Barrel Carb.	338 @ 2700 RPM	359 @ 2800 RPM
Brake Horsepower—2 Barrel Carb.	227 @ 4600 RPM	252 @ 4600 RPM
Torque (lb. ft.)—2 Barrel Carb.	333 @ 2300 RPM	354 @ 2400 RPM
Compression Pressure at Cranking Speed (8.5:1 Compression Ratio)	140-150 psi @ 155-165 RPM	
Compression Pressure at Cranking Speed (10.0:1 Compression Ratio)	155-165 psi @ 155-165 RPM	

Firing Order	1-8-4-3-6-5-7-2
Car-Engine Serial No. Location	Front Face of Right Cylinder Bank
Production Engine No. Location	Front Face of Right Cylinder Bank
Cylinder Nos.—Front to Rear	
Left Bank	1-3-5-7
Right Bank	2-4-6-8

CRANKSHAFTS

Material	Cast Pearlitic Malleable Iron
Journal Diameter	2.623-2.624
Bearing Length—bearing shell, including chamfer	
Front	15/16"
Front Center	15/16"
Center	15/16"
Rear Center Including Thrust Flanges	1.133-1.135
Rear	1.590
Thrust Taken On	Rear Center
Crank Pin Diameter	2.2488-2.2498
Journal and Pin Maximum Out of Round and Taper00025
Thrust Bearing End Play—Limits When New0035-.0085
Main Bearing Clearance—Limits When New	All except Rear .0005-.003 Rear .0008-.0033

CAMSHAFTS

Material	Alloy Cast Iron
Journal Diameter	1.8987-1.8997
Bearing—Inside Dia. (after line reaming)	1.9012-1.9017
Bearing Length	
Front	1.060
All others680
Bearing Clearance0015 to .0030
End Play003-.007

CONNECTING RODS

Length, center to center	6.63
Lower end bearing, inside diameter and length	2.2507-2.2517 x 7/8
Bearing clearance on crank pin—limits when new0009-.0029
End play of connecting rod on crank pin006 to .011
Pin bushing, inside diameter9807-.9811

PISTONS AND CYLINDERS

Cylinder bore out-of-round and taper when new001
Piston material	Aluminum Alloy

PISTONS AND CYLINDERS (Cont.)

Piston clearance in cylinder0007 to .0017
Piston fit using 1/2" x .0015 feeler	8-15 lbs. pull
Piston ring gap	
Compression rings	
Upper010 to .020
Lower008-.020
Oil Ring Segments015-.055
Piston ring to groove clearance	
Compression rings	
Upper0015 to .0030
Lower0015 to .0035
Oil ring assembly0025 to .0095

PISTON PINS

Fit in piston0000 to .0004 loose with piston & pin at 70°F.
Fit in rod0001 to .0006 loose
Diameter (selective)9803 to .9807
Length	3.13

FLYWHEEL

Teeth on ring	176
Teeth on starter pinion	9

VALVES

Material	
Intake	G.M. 8440 Steel
Exhaust	G.M. T-XCR Steel
Head Diameter	
Intake	1.88
Exhaust	1.60
Stem Diameter	
Intake3415-.3422
Exhaust3410-.3417
Seat Angle	
Intake	30°
Exhaust	45°
Valve Lift	
Synchro-Mesh373
Hydra-Matic Exhaust409
Hydra-Matic Intake373
Fit of stem in guide (new)	
Intake001 to .0027
Exhaust0015 to .0032

VALVES (Cont.)

Spring Pressure Compressed

Inner	54# to 60# @ 1.153
	23# to 29# @ 1.483
Outer	98# to 106# @ 1.203
	55# to 61# @ 1.533

VALVE TIMING

	S.M. Trans.	H.M. Trans.
Intake opens	22° BUDC	22° BUDC
Intake closes	67° ALDC	67° ALDC
Exhaust opens	63° BLDC	69° BLDC
Exhaust closes	27° AUDC	31° AUDC

VALVE LIFTER

Diameter8424-.8427
Clearance in boss0013 to .0028
Length-overall	2.000
Leakdown rate	12-40 seconds with 50# load
Plunger travel (for gauging purposes)125 (1/8")

TIMING CHAIN

Camshaft sprocket material	Cyanide hardened cast iron (cylinder iron)
Crankshaft sprocket material	Case hardened steel—SAE 1020 or 1022
Number of links in chain	60

TORQUE SPECIFICATIONS

	lb. ft.
Main Bearing Cap Screws (except rear main)	95
Rear Main Bearing Cap Screws	120
Cylinder Head Screws	95
Connecting Rod Cap Nuts	45
Flywheel Housing Screws	65
Rocker Arm Cover Screws	5
Push Rod Cover Screws	5
Oil Pan Screws	18
Fan to Water Pump Hub Screws	20
Water Pump Nuts	18
Intake Manifold to Cylinder Head Screws and Nuts	40
Exhaust Manifold to Cylinder Head Screws	25
Spark Plugs	25
Flywheel to Crankshaft Screws	95
Front Engine Insulator to Timing Chain Cover Screws	60
Rear Insulator to Frame Nuts	35
Valve Rocker Arm Ball Retaining Nut	15
Harmonic Balancer to Crankshaft Bolt	160

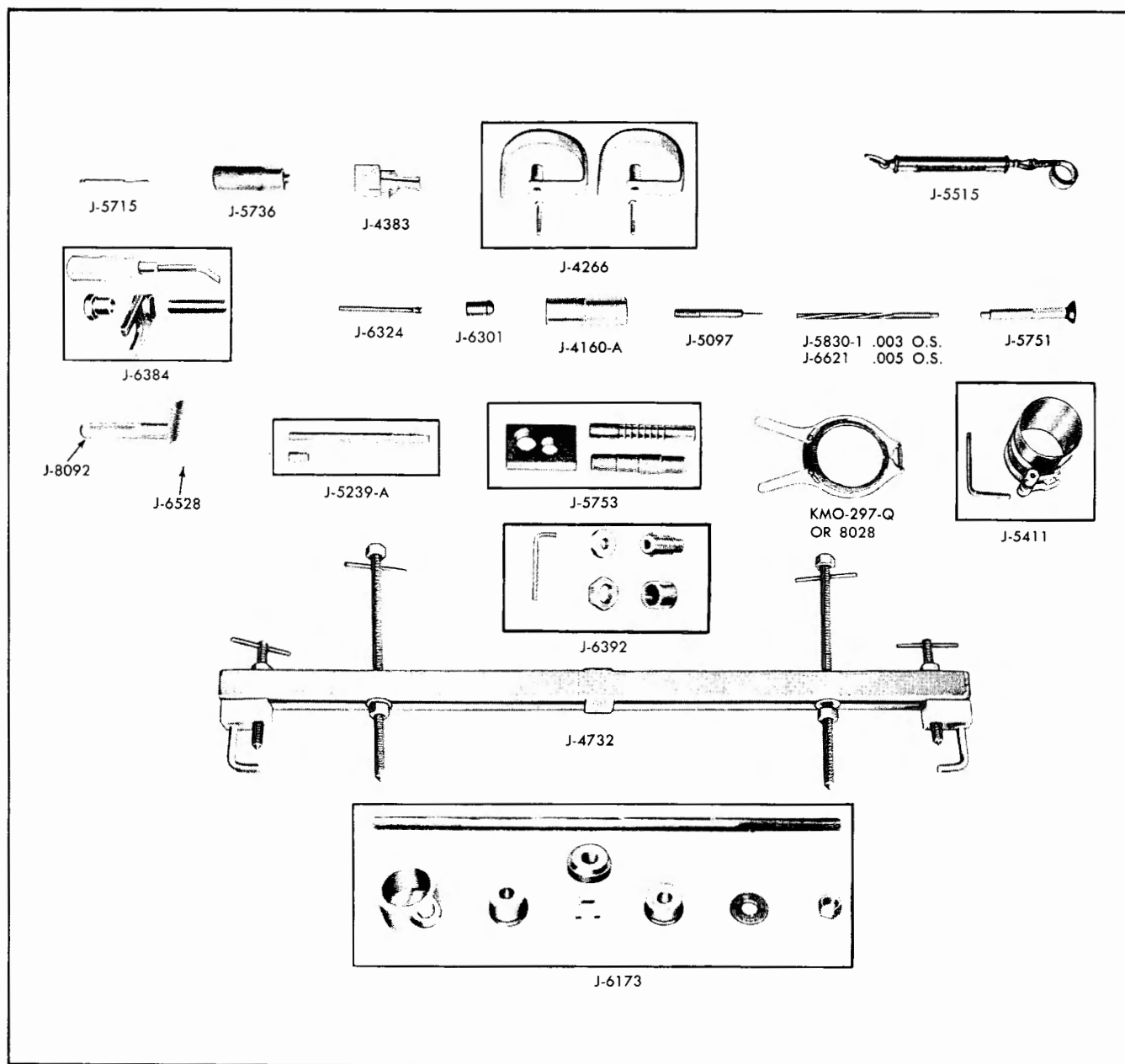

SPECIAL TOOLS—ENGINE

J-6528	Rear Main Bearing Oil Seal Installer	J-5830-1	Valve Guide Reamer .003 oversize
J-4160-A	Hydraulic Valve Lifter Plunger Remover	J-6621	Valve Guide Reamer .005 oversize
J-4266	Cylinder Head Lifting Hooks	J-5715	Rocker Arm Stud Reamer (oversize)
J-4732	Engine Support Bar	J-6392	Rocker Arm Stud Remover
J-5097	Hydraulic Valve Lifter Plunger Unloading Tool	J-6301	Rocker Arm Stud Installer
J-5239-A	Connecting Rod Bolt Guide Set	J-5736	Clutch Pilot Bearing Installer
J-4383	Clutch Pilot Bearing Remover	J-5751	Intake and Exhaust Valve Stem Seal Installer and Tester
J-5411	Piston Ring Compressor	J-5753	Connecting Rod Bushing Remover, Replacer, and Burnisher Set
J-5515	Piston Fitting Feeler Scale	J-6384	Valve Spring Compressor Set
J-6324	Valve Train Gauge	J-6173	Camshaft Bearing Remover and Replacer
J-8092	Rear Main Bearing Oil Seal Installer Handle	KMO 297Q or 8028	Piston Ring Remover and Replacer

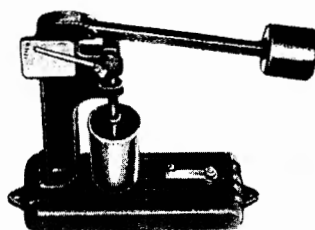
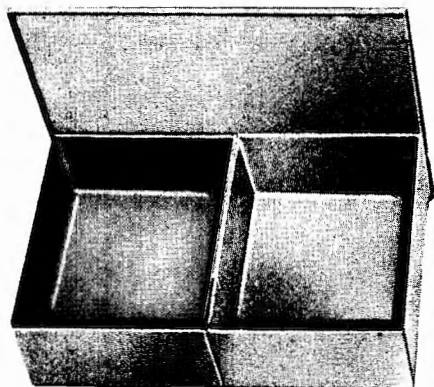

J-5790

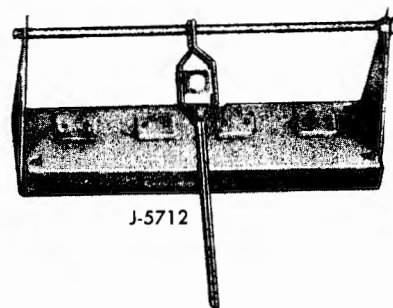

J-5712

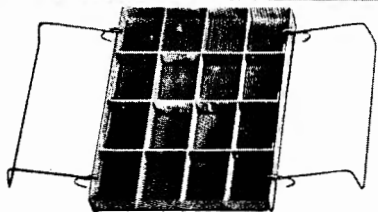

J-5821

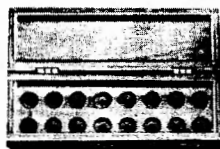

J-5763



J-5709

SPECIAL TOOLS—ENGINE

- J-5709 Valve and Valve Train Holding Stand
- J-5712 Cylinder Head Holder and Valve Spring Compressor
- J-5763 Hydraulic Valve Lifter Storage Box
- J-5790 Hydraulic Valve Lifter Tester
- J-5821 Hydraulic Valve Lifter Solvent Tank and Tray